



# **HP Belux Commercial Desktop Accessories**

**October 2015**

# Product Offering Changes



# New Products

N7H10AA	Chassis accessories	HP (10) 600/705/800 G2 SFF Bezel Sup Kit*
P1N74AA	Chassis accessories	HP (10 Sets) EliteDesk 800 G2 Tower Bezel Support Kit*
P1N69AA	Chassis accessories	HP EliteDesk 800 G2 SFF Bezel/Dust Filter *
P1N71AA	Chassis accessories	HP EliteDesk 800 G2 Tower Bezel/Dust Filter*
N4G86AA	Stands	HP 2x2 SFF Stand
N3R93AA	Security devices	HP Business PC Security Lock v2 Kit
N3R90AA	Graphics - enterprise multi display solutions	NVIDIA GeForce GT 730 2GB PCIe x8 GFX
N3R91AA	Graphics - enterprise multi display solutions	AMD Radeon R9 350 2GB DH PCIe x16 GFX
N1M40AA	I/O cards	HP PCIe x1 Parallel Port Card
P1N75AA	I/O cards	HP SuperSpeed USB 3.1 Gen 2 PCIe x1 Card*
E6D77A6#AC0	Keyboards	HP USB SmartCard CCID Keyboard -Bulk BEL

\* New as of the 5th of October 2015



# New Products

P2N45AA	Memory - DDR3L	HP 2GB DDR3L-1600 SODIMM (DDR3L-1600)
P2N46AA	Memory - DDR3L	HP 4GB DDR3L-1600 SODIMM (DDR3L-1600)
P2N47AA	Memory - DDR3L	HP 8GB DDR3L-1600 SODIMM (DDR3L-1600)
P1N51AA	Memory - DDR4	HP 4GB DIMM DDR4 Memory*
P1N52AA	Memory - DDR4	HP 8GB DIMM DDR4 Memory*
P1N53AA	Memory - DDR4	HP 4GB SoDIMM DDR4 Memory*
P1N54AA	Memory - DDR4	HP 8GB SoDIMM DDR4 Memory*
P1N55AA	Memory - DDR4	HP 16GB SoDIMM DDR4 Memory*
P1N68AA	Solid State Drive	HP 256GB SATA TLC Non-SED Solid State Drive
N1M42AA	Optical drives	HP Desktop G2 9.5mm Slim DVD-Writer Drive
N3S09AA	Optical drives	HP 9.5mm AIO 705/800 G2 Slim DVD-ROM Drive
N3S10AA	Optical drives	HP 9.5mm EliteOne 705/800 G2 Slim SuperMulti DVD Writer Drive
N3S11AA	Optical drives	HP 9.5mm EliteOne 705/800 G2 Slim SATA BDXL Blu-Ray Writer
P1N65AA	Optical drives	600 AIO G2 9.5mm Slim DVD-Rom Drive*
P1N66AA	Optical drives	600 AIO G2 9.5mm Slim DVD-Writer Drive*
P1N67AA	Optical drives	600 AIO G2 9.5mm Slim BDXL Blu-Ray Drive*

\* New as of the 5th of October 2015



# EOL Products



# Summary

- [Input Output Devices](#)
- [Memory Modules](#)
- [Graphic Cards](#)
- [I/O Cards](#)
- [Desktop Adapters](#)
- [Media](#)
- [Storage](#)
- [Optical Devices](#)
- [Security Solutions](#)
- [Workspace Enhancements](#)
- [LAN Solutions](#)
- [Mini Accessories \(Recap\)](#)
- [Software Solutions](#)



# Business PC Accessories

A wide array of accessories to complement your core PC purchase and provide maximum usability.



## Integrated work center stands & other workspace enhancements

For a productive, space-saving and comfortable Desktop experience, use the space-saving work centers that work like a docking station for the desktop PC, or the monitor arm for more flexibility

## Adapters

Select your choice from a complete range of adapters for improved productivity

## Software

Complete offer of software tools for online collaboration or remote management solutions

## Input /Output, Security & more

Be more productive with your PC by using a selection of I/O devices as well as securing your data and physical asset from theft/prying.

## Graphics & Memories

Enhance and expand your graphical capabilities with powerful graphics solutions, or upgrade more memory to boost your performance



# Input Output Devices





# HP Desktop Mini I/O Module

Keep working with your existing peripherals and add legacy ports to your HP Desktop Mini PC with the HP Desktop Mini I/O Module.



## Product Features and Benefits

- Have access to PS/2, Serial port and 2 additional USB 2.0 ports
- Sleek and slim HP specific design easily integrates this expansion option into your HP Mini environment
- Also has VESA mounting
- Can be physically be secured a Mini or another expansion module
- Compatibility HP 260 Desktop Mini, HP ProDesk 400 Desktop Mini, HP ProDesk 600 Desktop Mini, HP EliteDesk 705 Desktop Mini, HP EliteDesk 800 Desktop Mini

Product # K9Q84AA

# HP Conferencing Keyboard

Your collaboration command center.



Part #  
K8P74AA

## Product Features and Benefits

- Drive your Microsoft Lync voice and video calls directly from your HP Conferencing Keyboard and connect, disconnect, and manage your calls and videoconferencing settings with simple dedicated keys.<sup>1</sup>
- Connect through USB and get a full-sized quiet keyboard with intuitive, dedicated, illuminated keys for call functions and screen or video sharing. LEDs cue when you're on mute, sharing your screen, or your video is off during video calls.<sup>1</sup>
- Keep working with your familiar collaboration software, including Microsoft Lync.<sup>1</sup>
- Get the reassurance of a one-year limited warranty.

<sup>1</sup> Internet connection and voice service required and sold separately.



# COLLABORATION AND COMMUNICATION

## HP CONFERENCING KEYBOARD



Easy conferencing at your fingertips



### One touch simplicity

Dedicated keys for call controls such as answer, end, mute, share, video, contacts and calendar



### No more “talking on mute”

Keys illuminate to signal call/device status



### Maximum comfort and productivity

Full size, ultra quiet keyboard



### Skype for Business Optimized

Fully integrated with Skype for Business call controls and status indicators



# HP Smartcard CCID Keyboard (2013)

Add an extra layer of security at the point of data entry with the HP USB SmartCard CCID Keyboard, which includes an integrated smart card reader to help simplify access procedures and prevent unauthorized access to your PCs and networks



Product: E6D77AA/AT/A6

**!! A6 = Bulk Box : 10 keyboards !!**

## Product Features and Benefits

- Works with HP Client Security<sup>1</sup>. Combine with a smart card and HP Client Security<sup>1</sup> to create a secure and convenient way to log in.
- Expanded smart card compatibility. Enjoy enhanced security features vs. previous-generation technology with an integrated smart card reader that's compatible with Class A, B, and C smart cards to help prevent hacking and firmware changes in the keyboard.
- Get a sleek full keyboard that matches the latest HP Business PCs and is constructed with high-impact materials to withstand daily business use. Lubricated keys help keep your work environment quiet. The spill drain feature makes the keyboard easy to clean when accidents happen.
- Connect to any USB port on your PC, and you're ready to go. The included 6 ft (1.8 m) USB cable gives you plenty of room to move the keyboard around your workspace. For Windows, just plug into your system and the Windows Operating System installs the driver.



# HP PS/2 Keyboard

Maximize usage comfort and benefit from long-life durability with the HP PS/2 Keyboard for everyday business computing and simplified maintenance



Product # QY774AA/A6 (replacing DT527A)

## Product Features and Benefits

- Adjustable to 0° or 6° slopes with tilt legs to suit a variety of typing preferences.
- Built for durability and heavy usage, including a lifecycle rating up to 20 million keystrokes.
- Minimize damage from minor spills with the integrated spill-drain feature.
- Expect a faster set-up with quick and easy deployment for your IT atmosphere.
- **QY774A6#XXX = 14x Bulk pack version**



# HP USB Keyboard

Features impressively durable design built for ease of use and everyday business computing



## Product Features and Benefits

- Adjustable to 0° or 6° slopes with tilt legs to suit a variety of typing preferences.
- Built for durability and heavy usage, including a lifecycle rating up to 20 million keystrokes.
- Minimize damage from minor spills with the integrated spill-drain feature.
- Expect a fast set-up with quick and easy deployment for your IT atmosphere.
- **QY776A6#XXX = 14x Bulk pack version**

Product # QY776AA/AT/A6#xxx\* (replacing DT528A/AT/AL)



# HP USB Grey Keyboard (2012)

Features an impressively durable design built for ease of use and everyday business computing



Product # B6B64AA (replacing DT529A)

## Product Features and Benefits

- Adjustable to 0°, 6° slopes with tilt legs to suit a variety of typing preferences.
- Built for durability and heavy usage, including a lifecycle rating up to 20 million keystrokes.
- Minimize damage from minor spills with the integrated spill-drain feature.
- Expect a fast set-up with quick and easy deployment for your IT atmosphere.
- FN+F2 windows sleep function just like the sleep button on an HP consumer keyboard (half-moon on the small key)
- One Win8 key + one FN key (not two Win8 keys as on the old one)



# HP 2.4 GHz Wireless Keyboard and Mouse

Reduce the tangle and clutter associated with wired peripherals, regain valuable workspace, and place advanced functionality and ergonomic ease of operation at your fingertips



Product # QY449AA/AT

## Product Features and Benefits

### Keyboard

- Cordless radio frequency keyboard transmitter eliminates wires
- Proprietary key technology renders typing virtually noiseless
- Industry-standard QWERTY key layouts are available in 104 W, 105 W, 106 W, 107 W, and 109 W types and in 31 languages
- Encrypted digital radio transmission results in advanced security and reliability
- Batteries last up to 1 year or more; software warns when battery replacement is required
- Adjustable to 0° or 6° slopes with tilt legs to suit a variety of typing preferences.

### Laser Mouse

- High resolution laser technology for optimal performance and speed
- Cordless radio frequency mouse transmitter eliminates wires
- Scroll wheel speeds Web and document navigation, functions as a third button
- Batteries last up to six months or more; software warns when batteries need to be replaced
- 1000 DPI for smooth and accurate cursor control and navigation

### Receiver

- Cordless radio frequency transmitter eliminates wires
- Does not require line-of-sight access to keyboard and mouse
- Responds to a particular keyboard and mouse, allowing the use of multiple cordless systems in a single office
- Supports USB Suspend modes; provides wake-up by mouse motion or button press wheel scrolling, or keystroke
- Offers 78 channels and 65535 device IDs





# HP PS/2 Optical Mouse

Glides over a variety of surfaces with speed and accuracy using the latest advancements in optical tracking technology



Product # QY775AA (replacing EY703AA), DD440K (bulk 100units)

## Product Features and Benefits

- Get precision movement with a tracking system that works through light for less moving parts and greater durability than ball-based mice
- The optical sensor within the HP PS/2 Mouse employs a resolution of approximately 800dpi.
- Left-handed or right-handed users can enjoy a contoured shape that suits either preference, with a wheel that also functions as a third button
- A ball-free design reduces sticking and the need for constant cleaning.



# HP USB Optical Mouse

Utilize the latest optical sensing technology, recording precise motion over a variety of surfaces without a mouse pad



Product # QY777AA/AT/A6 (replacing DC172B & EA177A6)

## Product Features and Benefits

- Reduce sticking and constant cleaning with optical tracking - a system that works through light with less moving parts for greater durability than ball-based mice.
- Users benefit from a smooth, contoured shape that fits both hands - and a wheel that functions as a third button.
- The optical sensor within the HP US Optical Scroll Mouse employs a scan rate of 800dpi and enables crisp motion without a mouse pad, ball or roller.
- Left-handed or right-handed users can enjoy a contoured shape that suits either preference



# HP USB 1000dpi Laser Mouse

Get the speed and accuracy of laser tracking in a simple, elegant design - for the latest in laser sensing technology



Product #

K7W54AA (Grey mouse)

QY778AA/AT (replacing GW405AA/AT)

## Product Features and Benefits

- Manipulate fast or slow with precision on a variety of surfaces with high-performance laser accuracy. The wheel also functions as a third button when activated by pressing it.
- The HP USB Laser Mouse has no ball or moving parts, which improves its durability, reduces sticking and the need for constant cleaning.
- Left-handed or right-handed users can enjoy a contoured shape that suits either preference.

# Memory Modules



# HP DESKTOP MEMORY

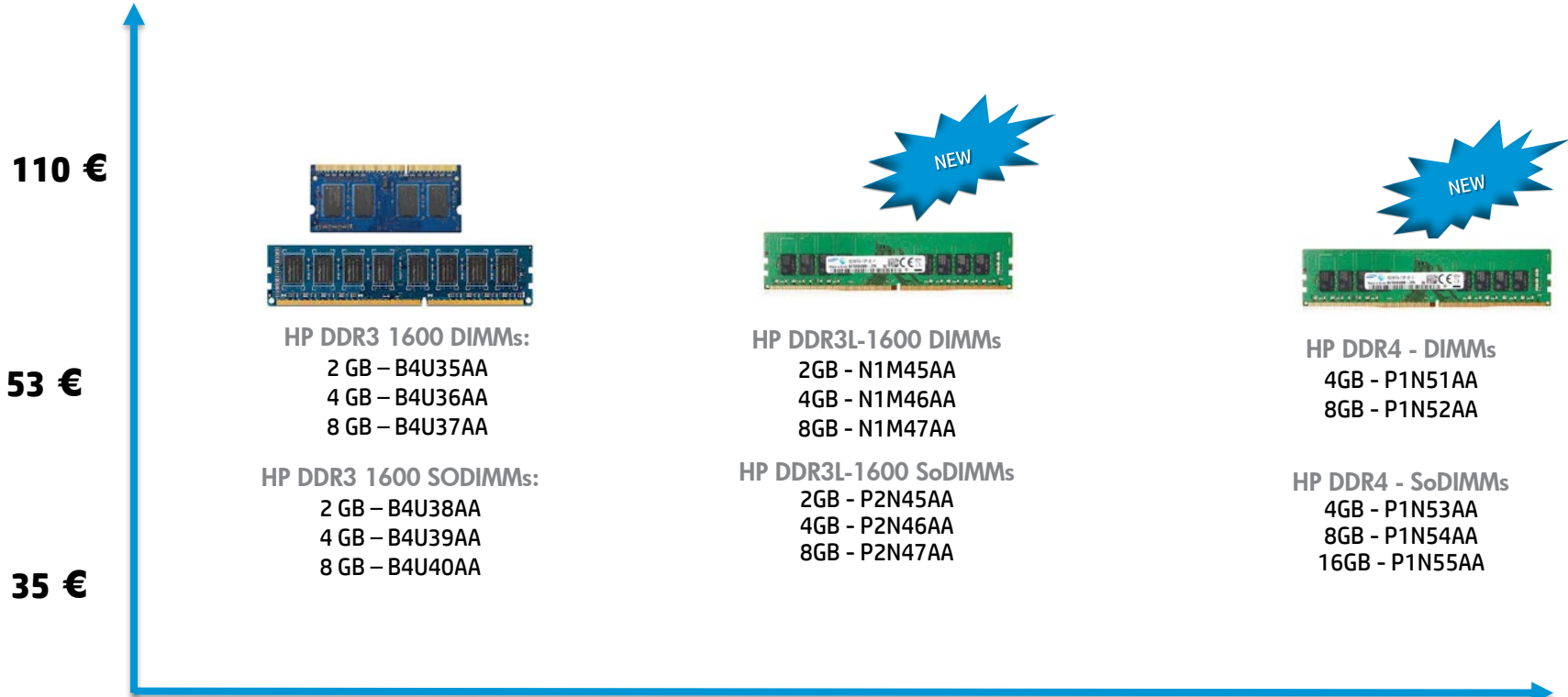

# HP DESKTOP MEMORY

Protect your investment with HP memory.

For MT/CMT/SFFs:



**HP DDR3 1600 DIMMs:**

- 2 GB – B4U35AA
- 4 GB – B4U36AA/AT
- 8 GB – B4U37AA/AT

For USDT/AIOs:



**HP DDR3 1600 SODIMMs:**

- 2 GB – B4U38AA (28)
- 4 GB – B4U39AA (48)
- 8 GB – B4U40AA (116)



# HP PC3-12800 (DDR3-1600MHz) DIMMs

Maximize your Business PC performance with HP Memory. Upgrading your memory is a cost-effective way to boost your system performance without having to upgrade your processor



Product # B4U35AA (replacing AT024AA) – 2GB  
Product # B4U36AA/AT (replacing VH638AA) – 4 GB  
Product # B4U37AA/AT - 8 GB

## Product Features and Benefits

- Faster start-up times with fewer delays during routine operations
- More programs running simultaneously
- Easy toggling between several open applications
- Rigorous supplier qualification processes for ensured quality
- Thoroughly tested by HP for high reliability
- Compatible with MT/CMT/SFFs

# HP PC3-12800 (DDR3-1600 MHz) SODIMMs

Maximize your Business PC performance with HP Memory. Upgrading your memory is a cost-effective way to boost your system performance without having to upgrade your processor



Product # B4U38AA (replacing VH640AA) – 2GB  
Product # B4U39AA (replacing VH641AA) – 4GB  
Product # B4U40AA - 8GB

## Product Features and Benefits

- Faster start-up times with fewer delays during routine operations
- More programs running simultaneously
- Easy toggling between several open applications
- Rigorous supplier qualification processes for ensured quality
- Thoroughly tested by HP for high reliability
- Compatible with USDT/AIOs



# Graphic Cards



# Graphic cards performance review - 2013 comparison

## A full range of graphics choices:

- Business Essentials Single Head

**VS**

- Business Essentials Dual Head

**VS**

- Business Essentials Performance

## And:

- NVIDIA NVS 310 PCIe X16 Card

**VS**

- NVIDIA NVS 315 PCIe X16 Card

Double click on the image to open embedded presentation or click [here](#) to download

Family data sheet HP recommends Windows.

## HP Business Desktop PCs graphics card options

Quick Reference Guide



The image shows a collection of HP Business Desktop PCs and graphics cards. On the left, there are two tower PCs. In the center, there is an HP All in One monitor displaying the HP logo and the text 'All in One'. In front of the monitor, there is a keyboard and a mouse. To the right of the monitor, there are two graphics cards: one is a standard PCIe X16 card, and the other is a more complex card with a fan and additional components.

September 2013



# HP Graphics Cards for Enterprise Business

Price



AMD Radeon HD 8350 (1gb) DH  
PCIe x16  
Graphics Card,  
E1C63AA



AMD Radeon  
HD 8490 DP  
(1GB) DH  
PCIe x16  
Card,  
E1C64AA



NVIDIA GeForce GT 630  
2GB DP PCIe FH x16 Crd,  
B4J92AA



NVIDIA NVS  
315 1GB PCIe  
x16 Graphics  
Card - VGA,  
E1C65AA



NVIDIA Quadro NVS 310  
PCIe x16 Graphics Card,  
A7U59AA

AMD

NVIDIA



# AMD Radeon HD 8350 (1gb) DH PCIe x16 Graphics Card

Get stable 2D and advanced 3D graphics performance from the AMD Radeon HD 8350 1 GB PCIe x16 DH GFX, a low profile, PCI Express x16 graphics add-in card based on the AMD Radeon HD 8350 GPU, great for Web conferencing or video and photo editing



Product # E1C63AA (replacing QK638AA)

## Product Features and Benefits

- Memory Size: 1GB , DDR3, 64bit wide bus
- Maximum Resolution: 2048 x 1536 VGA; 1920x1200 DVI
- Low Profile: 2.713 × 6.15 in (With full height bracket attached, Includes low profile bracket for SFF)
- Get Dual VGA from the DMS-59 connector, and Dual DVI output through the optional kit<sup>1</sup>. HDCP support on DVI provides enhanced security for your content.
- Get peak bandwidth support from the full 16-lane PCIe 2.0 bus. Eliminate the need to share PC system memory with 1 GB DDR3 dedicated on-board graphics frame buffer memory.
- Unleash the best graphics performance possible from your GPU with AMD Catalyst, which allows you to customize a stable, reliable experience and quickly and easily adjust your GPU for optimal video performance.

# AMD Radeon HD 8490 DP (1GB) DH PCIe x16 Card

Get impressive graphics and high resolution dual-display performance in a low profile, PCI Express x16 graphics add-in card based on the AMD Radeon HD 8490 Graphics Processor. Improve your everyday PC, Web conferencing, and video or photo editing



Product # E1C64AA (replacing B1R44AA)

## Product Features and Benefits

- Memory Size: 1GB , DDR3, 64bit wide bus
- Maximum Resolution: 2048 x 1536 VGA; 2560x1600 DVI-D & DP
- Low Profile: 2.713 × 6.15 in (With full height bracket attached Includes low profile bracket for installation into SFF)
- Enjoy current high-resolution monitor support from dual-link DVI and be future-ready with the multimode DisplayPort connector, which enables connection to DVI-D, VGA, and HDMI monitors.<sup>1</sup>
- The DisplayPort output also supports audio with video. HDCP support on DisplayPort and DVI provides enhanced security for your content.
- Get peak bandwidth support from the full 16-lane PCIe 3.0 bus. Eliminate the need to share PC system memory with 1 GB DDR3 dedicated on-board graphics frame buffer memory.
- Experience OpenGL4.0and DirectX 11 application support with compatibility integrated into the hardware.
- Unleash the best graphics performance possible from your GPU with AMD Catalyst, which allows you to customize a stable, reliable experience and quickly and easily adjust your GPU for optimal video performance.



# NVIDIA GeForce GT 630 2GB DP PCIe FH x16 Crd

Provides a full height, PCI Express x16 graphics add-in card solution based on the NVIDIA Kepler Architecture GPU. The card is designed to support three display connections through its DVII, and two DisplayPort connectors



Product # B4J92AA

## Product Features and Benefits

- 2 GB of DDR3 dedicated on-board graphics frame buffer memory removing the need to share PC system memory
- Features the latest NVIDIA Kepler Architecture GPU Support
- Run multiple displays from a single graphics board
- DisplayPort 1.2 hardware ready for future multi-monitor support
- Provides Dual-Link (DL) DVI-I and two multimode DisplayPort output ports (useable at the same time)
- Also supports legacy displays using adapters:
  - ✓ DVI-I to VGA adapter (1 included)
  - ✓ HP DP to DVI-D adapter FH973AA (1 included)
  - ✓ HP DP to HDMI adapter BP937AA (optional)
  - ✓ HP DP to VGA adapter AS615AA (optional)
  - ✓ HP DP to dual link DVI-D adapter NR078AA (optional)
- Supports Audio over DisplayPort for users who need audio with video thru the DisplayPort connector. Audio is also supported with the optional HP DP to HDMI adapter (BP937AA).
- Audio is also supported using DVI to HDMI adapters (Adapters not available from HP)
- Conforms to full PCI Express 3.0A specification for full height form factor (x16 lanes native PCI Express implementation)
- HDCP supported on DVI and DisplayPort outputs
- DirectX11 support in hardware for optimal performance in DX11 applications
- OpenGL 4.2 support in hardware for optimal performance with OpenGL applications

# NVIDIA NVS 315 1GB PCIe x16 Graphics Card - VGA

Get efficient dual-display graphics performance in a PCI Express low-profile graphics card with the NVIDIA NVS 315 PCIe x16 1 GB Graphics Card, an ideal desktop graphics solution for professional business and commercial applications



Product # E1C65AA (replacing BV456AA)

## Product Features and Benefits

- Enjoy the speed of 1 GB of dedicated DDR3 graphics memory. Help conserve power with NVIDIA Power Management technology, which helps reduce energy costs by adapting graphics power according to application usage.
- Maximum Resolution: 2048 x 1536 VGA; 1920x1200 DVI, 2560x1600 DisplayPort
- Low Profile: 2.713 × 6.15 in (With full height bracket attached; Includes low profile bracket for installation into SFF)
- Maximize your productivity and drive two VGA, single link DVI or DisplayPort displays from a single card.
- Improve system performance with 48 CUDA parallel-computing cores that boost the power of the GPU and are compatible with CUDA-accelerated applications.
- Expand your view and drive dual displays from a single desktop with NVIDIA Mosaic Technology. Once the card is installed, the system can view both displays as a single unified desktop environment—no need to customize software.
- Be organized and more productive throughout the day with NVIDIA nView Desktop Management. Organize windows across your displays, maximize workspace, and use a single toolbar for both screens.

# NVIDIA Quadro NVS 310 PCIe x16 Graphics Card

A PCI Express low profile form factor graphics add-in card targeted as an active low cost graphics solution for the corporate business and enterprise markets



Product # A7U59AA (WS leveraged)

## Product Features and Benefits

- Offers 512 MB of ultrafast DDR3 memory
- Capable of supporting up to 2 displays in the following configurations:
- DisplayPort output:
  - Drives two DisplayPort enabled digital display at resolutions up to 2560 × 1600 at 60 Hz with reduced blanking, when connected natively using the 2 DisplayPort connectors on the NVS 310 graphics card
  - Supports 2 monitors up to resolution of 1920 × 1200 at 60 Hz with reduced blanking using DisplayPort 1.2 multi stream topology technology.
- DVI-D output:
  - Drives two digital display at resolutions up to 1920 × 1200 at 60 Hz with reduced blanking using DisplayPort to DVI-D single-link cable adaptors
  - Drives two digital display at resolutions up to 2560 × 1600 at 60 Hz with reduced blanking using DisplayPort to DVI-D dual-link cable adaptors
- HDMI output:
  - NVS 310 is capable of driving two high definition (HD) panels up to resolutions of 1920 × 1080P at 60 Hz using DisplayPort to HDMI cable adaptors
- VGA display output:
  - Drives two analog display at resolutions up to 1920 × 1200 at 60 Hz using DisplayPort to VGA cable adaptors





# Graphic Adapters



# Benefits of Dual Monitors

## Increase Productivity Up to 35% with More Screen Real Estate

See more. Do more.

- Multi-tasking (ex: see email while working on other tasks)
- Access multiple applications simultaneously
- View documents side by side (ex: edit a new document while seeing the original)
- Reduce excessive toggling between screens, shuffling/resizing windows, mouse-clicking and scrolling in small windows
- Easier cutting/pasting between documents
- Reduce the need for printed materials

### HP Productivity Study On Using Dual Monitors (vs. a single monitor)

For the typical office worker, dual monitors **increase average productivity 9% to 35%** while performing common computer tasks (word processing, spreadsheets, email, web browsing).



# Enabling Dual Monitors

- HP Monitor Stands
- HP USB Graphics Adapters
- HP Docking Stations
- HP Port Replicators



# HP Graphics Adapters

	Adapter:	Orderable SKU:	Comments:
<b>DisplayPort</b>	DisplayPort to DVI-D	FH973AA	•Included with most HP Workstation cards to support non-native DVI output
	DisplayPort to dual link DVI	NR078AA	•Dual link supports 30" displays (2560x1600 resolution)
	DisplayPort to HDMI	BP937AA	•Supports audio over DP
	DisplayPort to VGA	AS615AA	•VGA support
<b>DMS-59</b>	DMS-59 to dual DVI-I	DL139A	•“Y” cable transmits two DVI video signals on a single connector
	DMS-59 to dual VGA	GS567AA	•“Y” cable transmits two VGA signals on a single connector (9H)
	DMS-59 to dual DisplayPort	XP688AA	•New! (9H)
<b>DVI</b>	DVI to VGA	VE053AA	•VGA support (9H)



# HP Graphics Adapters

Price

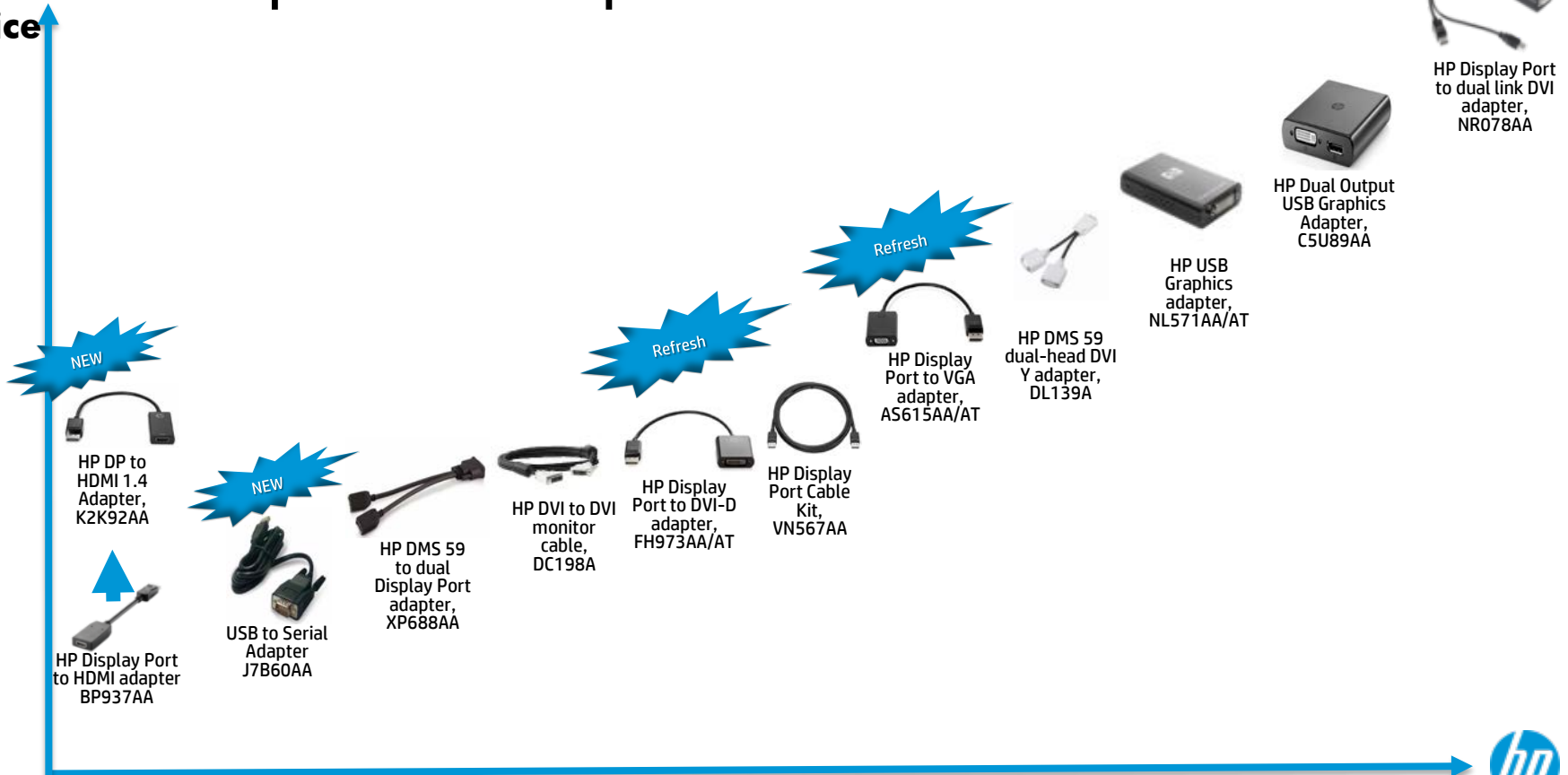

# New AMO Kits – Graphics

New

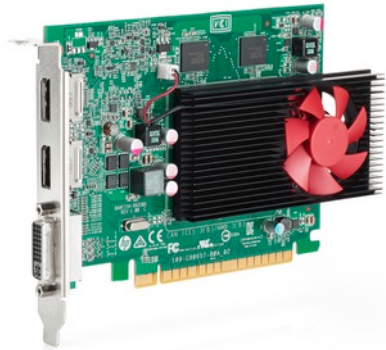

## AMD Radeon R9 350 PCIe x16 Graphics Card

### What is It?

- AMD Radeon R9 350 PCIe x16 Graphics Card

### OS Support

- Windows 7/8.1/10

### Driver needed

- Yes, driver needed for Windows

### Customer Benefits

- 2GB gDDR5 video memory
- DirectX 12 support for Win10
- Dual DisplayPort and DVI-D support (for VGA adapter support)
- Low profile card for SFF and Tower support

### AMO Part #

- AMO Kit # N3R91AA

# New AMO Kits – Graphics

New



## NVIDIA GeForce GT 730 2GB PCIe x8 Graphics Card

### What is It?

- NVIDIA GeForce GT 730 2GB PCIe x8 Graphics Card

### OS Support

- Windows 7/8.1/10

### Driver needed

- Yes, driver needed for Windows

### Customer Benefits

- 2GB DDR3 video memory
- Directx 12 support for Win10
- DisplayPort and DVI-D support (for VGA adapter support)
- Low profile card for SFF and Tower support

### AMO Part #

- AMO Kit # N3R90AA

# HP DisplayPort to HDMI Adapter

Converts the DisplayPort connector on a HP Compaq Business Desktop computer or HP Workstation to a HDMI port. The adapter has a latching DisplayPort connector on one end and HDMI connector on the other for connecting to a HDMI monitor cable.



Product # BP937AA

## Product Features and Benefits

- Converts a graphics card's DisplayPort output to a HDMI output for use with a HDMI monitor.
- Adapter length (approximate): 8 in (20 cm)
- Latching DP connector for a secure connection



# HP DisplayPort to HDMI 1.4 Adapter

Converts the DisplayPort connector on a HP Compaq Business Desktop computer or HP Workstation to a HDMI port. The adapter has a latching DisplayPort connector on one end and HDMI connector on the other for connecting to a HDMI monitor cable.

## Product Features and Benefits

- Converts a graphics card's DisplayPort output to a HDMI output for use with a HDMI monitor.
- Adapter length (approximate): 8 in (20 cm)
- Latching DP connector for a secure connection

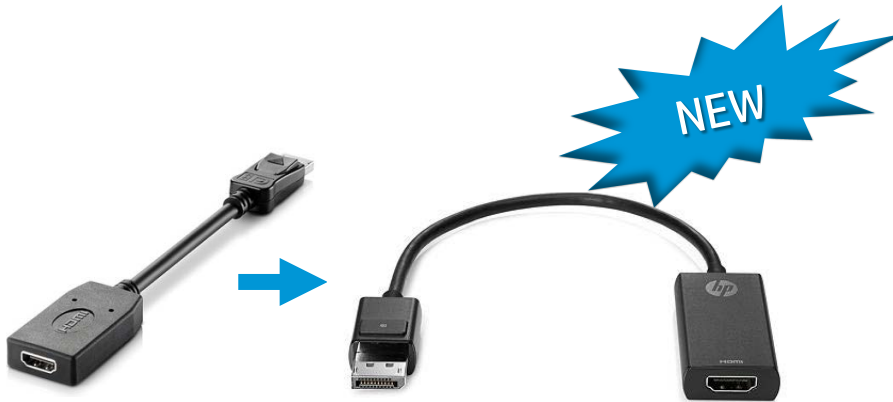

Product # BP937AA replaced by  
K2K92AA, HP DP to HDMI 1.4 Adapter

# HP USB to Serial Adapter

Quickly and easily add a serial port to your desktop to connect to your serial and parallel peripherals with the HP USB to Serial Port Adapter, which plugs into any USB port on your PC.



Product # J7B60AA

## Product Features and Benefits

- Compatible USB2.0/3.0
- Cable length: 1.2m
- Windows XP/Vista/7/8/8.1 (X86/X64)
- Expands one independent RS-232 serial ports through USB A type interface.
- Supports both USB bus power modes without additional external power
- Enjoy USB connection speed up to 12 Mbps and serial communication speed up to 115.2 Kbps



# HP DMS-59 to Dual DisplayPort Kit

Support up to two digital displays with the use of this optional DMS-59 to DisplayPort adapter



Product # XP688AA (WS leveraged)

## Product Features and Benefits

- Avoidance of problems caused by an infrastructure that is not at the current revision level
- Improved performance through regular Proactive Scans to help ensure that systems are configured consistently with HP best practices.
- Simplified operations from fully utilizing management software
- Flexible resourcing through access to skills on demand that can help with peak workload and project requirements
- Technical Information
  - 2-way
  - Connector on First End 1 x 59-pin DMS-59 Video
  - Connector on Second End 2 x DisplayPort Female Digital Audio/Video
  - Conductor Copper



# HP DVI to DVI Cable

Connect to external monitors with a DVI connector from an HP Compaq Business Desktop computer with a DVI connector. The cable is a single link cable with DVI-D support on both connectors. The cable will connect to either a DVI-D or DVI-I connector on the monitor and the graphics card.



Product # DC198A

## Product Features and Benefits

- Connect to graphics cards and monitors that have a DVI connection with single link support.
- Length (approximate): 6.56 ft (2 m)
- Also available in bulk pack : 35 pieces: DC198A6

# HP DisplayPort to DVI-D Adapter

Converts the DisplayPort connector on a HP Compaq Business Desktop computer or HP Workstation to a HDMI port. The adapter has a latching DisplayPort connector on one end and HDMI connector on the other for connecting to a HDMI monitor cable



Product # FH973AA/AT

## Product Features and Benefits

- Converts a graphics card's DisplayPort output to a DVI output for use with a Single Link DVI-D monitor.
- Adapter length (approximate): 8 in (20 cm)
- Latching DP connector for a secure connection

# HP DisplayPort Cable Kit

Connects a DisplayPort connector on an HP Business Desktop computer to a DisplayPort connector on a monitor



Product # VN567AA

## Product Features and Benefits

- Connects a DisplayPort connector on an HP Business Desktop computer to a DisplayPort connector on a monitor.
- 6.6 ft (2.0 m) cable

# HP DisplayPort To VGA Adapter

Converts the DisplayPort connector on a HP Compaq Business Desktop computer or HP Workstation to a VGA port. The adapter has a latching DisplayPort connector on one end that connects to the graphics source and VGA connector on the other for connecting to a VGA monitor cable.



Product # AS615AA/AT

## Product Features and Benefits

- Converts a graphics card's DisplayPort output to a VGA output for use with a VGA monitor.
- Adapter length (approximate): 8 in (20 cm)
- Latching DisplayPort connector for a secure connection

# HP DMS 59 dual-head DVI Y adapter

DMS-59 to Dual DVI Cable Kit for NVIDIA NVS series graphics cards is compatible with the NVIDIA NVS 300



## Product Features and Benefits

- Dual output breakout cable is a Y-shaped cable adapter that has a DMS-59 male connector on one end and 2 DVI-I female connectors on the other end
- Length: 8inch
- Connectivity
  - Connector(s) 2 x 24 pin digital DVI - female
  - Connector(s) (Other Side) 1 x DMS-59 - male

Product # DL139A





# HP USB Graphics Adapter

Add more displays and increase your digital desktop, drag-and-drop applications onto their own display enables you to easily see more information



Product # NL571AA/AT (Monitor leveraged)

## Product Features and Benefits

- Office: View large spreadsheets across two screens or multitask without overlapping windows
- On the road: Enable multiple screen presentations from one PC
- Graphics houses: Use a second display for palettes or tools or a panoramic view of large documents
- Editing: Edit documents on one screen and reference data on another; compare multiple documents simultaneously
- Financial: Use one monitor for each data stream
- Connecting via USB only
- No power cable needed, save up to 80% power consumption when using a USB adapter compared to its alternative: a standard graphics card
- Win8 supported, [download the new driver](#)



# HP Dual Output USB Graphics Adapter

You can boost your productivity by creating a dual-monitor setup with the HP Dual Output USB Graphics Adapter – featuring both DVI-I and DisplayPort inputs to drive displays at high resolutions through a single USB 3.0 connection to your PC.



Product # C5U89AA (Monitor leveraged)

## Product Features and Benefits

- Enhance your on-screen graphics presentation with two digital outputs, including DisplayPort. Support DVI-I resolutions up to 1920 x 1200 and DisplayPort resolutions up to 2560 x 1600.
- Experience high-speed USB 3.0 technology. The single USB 3.0 cable on the HP Dual Output USB Graphics Adapter not only expands your productivity with connection to two external monitors, but also provides faster transfer speeds than USB 2.0.
- Widely compatible with most PCs and notebooks, the USB 3.0 connection on the HP Dual Output USB Graphics Adapter is compatible with older models - and is even backwards compatible to USB 2.0 connections.
- Setup is quick and easy with a USB plug-and-play design and one-time driver installation. Support your entire dual-monitor environment through a single USB 3.0 connection. Less hassle. Less clutter. Less stress.
- Create a true hot-desk atmosphere and provide a dual-monitor station for workers when and as needed - ideal for office spaces shared by multiple workers on different shifts.
- More cost-effective and energy-efficient than many docking stations and graphics cards, the HP Dual Output USB Graphics Adapter proves that less really is more.



# HP DisplayPort to Dual Link DVI Adapter

Boost your productivity by converting a graphics card's DisplayPort output to dual link DVI.



Product # NR078AA (WS leveraged)

## Product Features and Benefits

- Converts a graphics card's DisplayPort output to dual link DVI.
- Resolution up to 2560x1600.
- Supports all HP monitors that feature dual link DVI interface, including the HP LP3065 30-inch Widescreen LCD Monitor.
- Latching DP connector for a secure connection.
  - Connector on First End 1 x DisplayPort Video
  - Connector on Second End 1 x DVI Digital Video
  - Conductor Copper

# I/O Cards



# HP Desktop/Media Adapters

Price



HP Parallel Port Adapter (no USDT) KD061AA



HP Serial Port Adapter, PA716A



HP 15-in-1 USB2/3 3.5 Media Card Reader, F4N90AA



HP USB 3.0 4-Port SuperSpeed PCIe x1 Card QT587AA



HP PCI Expansion Slot Kit, E1V16AA



# New AMO Kits – I/O



## HP SuperSpeed USB 3.1 Gen 2 PCIe x1 Card

### What is It?

- HP SuperSpeed USB 3.1 Gen 2 PCIe x1 Card

### OS Support

- Windows 7/8.1/10

### Driver needed

- Yes, driver needed for Windows 7

### Customer Benefits

- New USB 3.1 performance doubling the transfer speed compared to USB 3.0
- Type-C connector for latest USB connector (no power delivery support)
- Plug-N-Play support with I/o address and IRS assigned by the platform

### AMO Part #

- AMO Kit # P1N75AA

# HP HP PCIe x1 Parallel Port Card

Connect to external device such as printers with the HP Parallel Port Card. This adapter provides a parallel port support that can be used to connect to parallel interfaced devices.



## Product Features and Benefits

- Expands single Parallel LPT Port on the platform
- Full PCIe Slot throughput
- Plug-N-Play support with I/o address and IRS assigned by the platform
- Windows driver needed
- OS supported: Windows 7/8.1/10

Product # N1M40AA



# HP Parallel Port Adapter

Connect to external device such as printers with the HP Parallel Adapter. This adapter provides a parallel port support that can be used to connect to parallel interfaced devices.



Product # KD061AA

## Product Features and Benefits

- Connect to external devices such as printers
- Parallel port support



# HP Serial Port Adapter

Need to add various devices to your HP Business Desktop but only have one serial port? Connect the HP 2nd Serial Port Adapter into the existing serial port of certain HP Business Desktops to support a wide variety of devices with a serial connector.

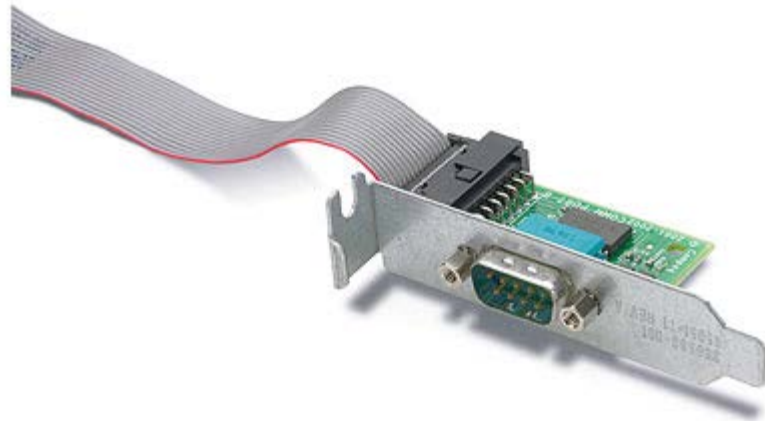

Product # PA716A

## Product Features and Benefits

- Connect to external devices such as printers
- Parallel port support

# HP 15-in-1 USB2/3 3.5 Media Card Reader,

Quickly and easily backup your files and transfer your data, pictures, video, and projects between your PC and 15 types of storage media with the HP 15-in-1 Media Card Reader.



Product # F4N90AA (replacing E5G19AA)

## Product Features and Benefits

- Enjoy compatibility with 15 types of storage media.
- Get fast USB 3.0 read/write capabilities
- Insert into any available 5.25" or 3.5" bay on your HP Business Desktop PC

# HP USB 3.0 2x2 Port SuperSpeed PCIe x1 Card

Provides increased data transfer and greater bandwidth to USB devices connected to your computer

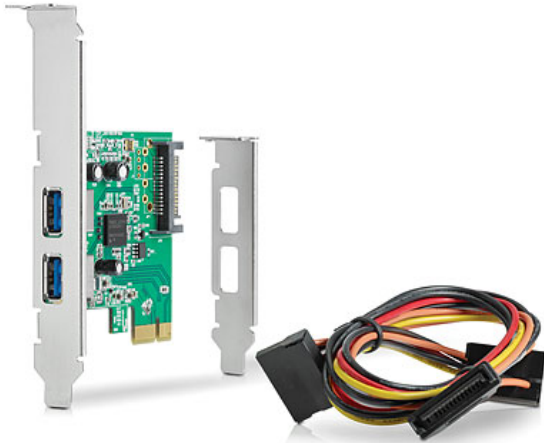

Product # QT587AA (replaced BM867AA)

## Product Features and Benefits

- Has a 5 Gbps signaling rate and can provide up to a 10x performance increase over Hi-Speed USB 2.0
- Sync-N-Go technology that minimizes user wait-time
- Provides Optimized Power Efficiency. No device polling and lower active and idle power requirements
- Backwards compatible with USB 2.0. Devices interoperate with USB 2.0 platforms. Hosts support USB 2.0 legacy devices



# HP PCI Expansion Slot Kit

Expand and increase your PC system capabilities quickly and efficiently with the HP PCI Expansion Slot Kit—complete with a PCI card slot and connector to PCA board. Support your existing PCI cards with an easy setup and installation.<sup>1</sup>



Product # E1V16AA

## Product Features and Benefits

- Specifically designed to customize and enhance the HP EliteDesk 800 G1 Tower Desktop PC with a backwards compatibility slot
- Maintain existing peripheral demands with built-in support for full-height PCI cards
- Easy slot setup with system board connector and screws

# Media



# HP Audio-Video Devices

Price



HP  
Business  
Headset,  
QK550AA



HP USB  
Business  
Speakers,  
D9J19AA



HP LCD  
Speaker Bar  
(Black),  
NQ576AA/AT



HP HP USB  
HD 720P v2  
Business  
Webcam,  
D8Z08AA



# HP Business Headset

Comfortable and lightweight, the HP Business Headset provides a headset that is perfect for call centers, telephone-intensive jobs, or casual use while working at your desk



Product # QK550AA

## Product Features and Benefits

- Flexible design lets you adjust the headset for your comfort
- Create a quiet communication environment with the noise-canceling microphone and volume controls
- Full range of 270° microphone boom rotation
- Clear sound quality lets you hear important online meetings, or enjoy the music while you work



# HP USB Business Speakers

Quickly and easily add stereo sound to your workspace with USB-powered speakers. Get enhanced sound quality from the integrated DTS Sound Software<sup>1</sup>



Product # D9J19AA

## Product Features and Benefits

- Simply connect the speakers to any USB port on your PC.
- White LED confirms power. When you want to listen privately, use the stereo headset connection on the right speaker.
- Get improved acoustic performance from the new, large resonance chamber and bass reflex port.
- Enhance your sound with the dynamic and subtle nuances of DTS Sound Software, available on the included software.<sup>1</sup>





# HP LCD Speaker Bar (Black)

Because we recognize that your monitor is the center of your computing world, HP offers a variety of optional products (each sold separately) designed to complement our monitors and enhance the overall computing experience.

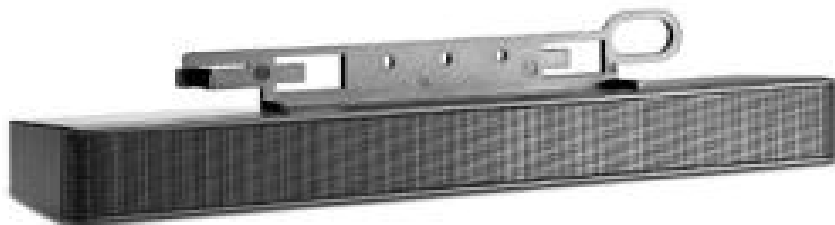

Product # NQ576AA/AT

## Product Features and Benefits

- Delivers two watts of total RMS output for a quality business audio experience
- Designed to easily attach and visually complement selected models of current and future HP LCD monitors (see compatibility chart below)
- Secures to the monitor with a Kensington lock slot
- Tested and qualified with HP Business Desktop and LCD monitors



# HP USB HD 720P v2 Business Webcam

Easily connect with colleagues for all of your videoconferencing needs.<sup>1</sup> The HP USB HD 720p Business v2 Webcam delivers professional video/audio in a compact design that connects to any USB port on your PC and sits neatly on top of your monitor.



Product # D8Z08AA

## Product Features and Benefits

- Image sensor: 1 MP sensor, 1280 x 800p, CMOS
- Effective Focal Range: 30 to 70 cm
- View Angle: 69 degrees diagonal
- Enjoy a business-class 720p, true 16:9 HD image and 360° pan/30° tilt adjustability that captures multiple users.
- Reduce background noise during videoconferencing<sup>1</sup> with the directional microphone
- Get up and running quickly with the included USB cable and easy software installation. Simply clip the webcam to your monitor and you're ready to go
- The lightweight and ultra-compact design clips neatly onto your LED or LCD monitor without blocking the screen, so you can leave it attached when not in use



# Storage



# HP Storage

Price



HP 500GB  
SATA 6.0Gb/s  
Hard Drive,  
QK554AA/A6



HP  
Removable  
SATA Hard  
Drive  
Enclosure  
(frame &  
carrier),  
RY102AA



HP 500GB  
SATA 6G 2.5  
(8GB Cache)  
SSHD Drive,  
E1C62AA



HP 1TB  
SATA  
6.0Gb/s  
Hard Drive,  
QK555AA/A  
6



HP Slim  
Removable  
SATA HD  
Frame/  
Carrier,  
C1N41AA,  
E3F39AA



HP 128Gb  
SED Opal 2  
SSD Drive ,  
G1K24AA



HP 128GB  
SATA Solid  
State Drive  
Desktop,  
QV063AA



NEW  
PCIe x4  
M.2  
128GB  
SSD Card,  
J5V07AA



NEW  
HP Desktop  
Mini 500GB  
HDD/I/O  
Module  
K9Q82AA  
Dec-16



Intel Pro  
1500 180GB  
SATA SED  
Opal1 Solid  
State Drive,  
G4M04AA



# New AMO Kits – Storage

New



## HP 256GB SATA TLC Non-SED Solid State Drive

### What is It?

- HP 3D 256GB Non-SED Solid State Drive

### Customer Benefits

- 256GB capacity size
- TLC (Triple Layer Cell) NAND drive technology
- Value SSD drive for AMD G2 platforms
- SATA 6Gbps interface
- Performance for Client desktop market

### AMO Part #

- AMO Kit # **P1N68AA**

# HP 256GB SATA 3D Non-SED Solid State Drive



## HP 3D 256GB Non-SED Solid State Drive

### What is It?

- HP 3D 256GB Non-SED Solid State Drive

### Customer Benefits

- 256GB capacity size
- First 3D 32-layer vertical NAND technology drive in the market
- Sata 6Gbps interface

### Part #

- N1M49AA

# HP Serial ATA 6.0-Gb/s Hard Drives

Serial ATA provides faster data transfer speeds, better system cooling airflow, more bandwidth, more headroom for speed increases in future generations and better data integrity. A next-generation technology, Serial Advanced Technology Attachment (SATA) interface connects hard drives to the PC platform enabling easy aggregation of multiple hard drives into a single PC.



Product # QK554AA/A6 (500GB, Bulk = 25units)

Product # QK555AA/A6 (1TB)

## Product Features and Benefits

- Improved protocol for enhanced data integrity
- Enhanced security prevents access to user data until one or two user-defined passwords are provided
- Performance increase to up to 6Gb/s maximum external (burst) data transfer rate
- Thinner and smaller serial cables and connectors for easy routing and improved system cooling
- SMART IV technology constantly checks that the data flow from host interface to media and media to host interface is not compromised.
- Native Command Queuing allows the hard drive to have several write or read commands outstanding at the same time
- Maximum cable length increased from 1.5 feet to 1 meter (3.28 feet) for increased design and layout flexibility in a system



# HP Removable SATA Hard Drive Enclosure (frame & carrier)

Robust all-metal construction provides superior cooling while protecting the hard drive during transportation and storage



Product # RY102AA

## Product Features and Benefits

- Removable hard drive for your HP Business Desktop.
- Smaller design --- Integrates easily in any available 5.25" half-height storage bay
- Provides superior cooling while protecting the hard drive during transportation and storage
- Powered key lock prevents theft or accidental removal during operation
- Install the receiving frame into an available 5.25" optical storage bay and then relocate your primary system hard drive or secondary hard drive to the removable drive carrier
- Advanced Connector Technology - Industry leading 30,000 Insertion Rating
- Improved Cooling Features - Thermal sensing Vapo Bearing MagLev Fan
- Support for up to 3.0Gb/sec SATA Hard Drives - Takes advantage of Latest Serial ATA Hard Drive Interface Specifications





# HP 500GB SATA 6G 2.5 (8GB Cache) SSHD Drive

Get the responsiveness of solid state memory and the capacity of a hard drive in a highly affordable package with the HP 500GB SATA 6G 2.5 (8GB Cache) solid state hybrid drive (SSHD), which delivers fast boot-up, shut down, and application loading



Product # E1C62AA

## Product Features and Benefits

- Enjoy 8 GB of solid state memory and 500 GB of hard drive capacity in a compact, hybrid drive design that delivers a faster boot-up and enhanced application performance compared to a conventional hard disk drive.
- Enjoy super-fast access to the files you use most with Adaptive Memory™ technology, which copies frequently-used data stored on the hard drive to solid state memory for faster loading.

# HP Slim Removable SATA HDD Frame/Carrier

Help protect your hard drive inside a sturdy metal carrier and quickly move your data or boot drive to a secure location at the end of the day with the HP Slim Removable SATA HDD Carrier/Frame.



Product # C1N41AA

## Product Features and Benefits

- Simply insert your 2.5-inch SATA hard disk drive<sup>1</sup> into the sturdy metal carrier and it's ready to move to a secure location at the end of the day.
- Enjoy SATA data transfer speeds up to 6 Gb/s when used with 6 Gb/s drives and hosts (drive and PC sold separately).
- Use the included frame to have a staging area for the carrier already installed in your PC.

# HP Slim Removable SATA HD Carrier Only

Help protect your hard drive inside a sturdy metal carrier and quickly move your data or boot drive to a secure location at the end of the day with the HP Slim Removable SATA HDD Carrier/Frame.



Product # E3F39AA

## Product Features and Benefits

- Simply insert your 2.5-inch SATA hard disk drive into the sturdy metal carrier and it's ready to move to a secure location at the end of the day.
- Enjoy SATA data transfer speeds up to 6 Gb/s when used with 6 Gb/s drives and hosts (drive and PC sold separately).
- Use the included frame to have a staging area for the carrier already installed in your PC.

# HP 250/500GB SATA 10K SFF HDD

Extend the life of your HP Business Desktop by providing additional storage



Product # C2T89AA (250Gb)

Product # C2T90AA (500Gb)

Product # C2T91AA (1TB)

## Product Features and Benefits

- SATA 7200 rpm drives are our standard high bandwidth hard drive storage options; most workstation models are also available with high performance 10K rpm rotation speeds
- Easy low-cost back-up solution without burdening network resources
- Standard size 10k drive
- SMART predictive failure analysis (PFA)

# HP Solid State Drives (SSDs)

Boost the performance and robustness of your HP Business Desktop PC with an HP Solid State Drive



Product # G1K24AA (128GB)

## Product Features and Benefits

- Take the worry out of storing your data with a hard drive with no moving parts
- Get faster transfer speeds and higher cell endurance with Intel NAND flash memory Multi Level Cell (MLC) components
- Significantly improve boot up, shut down and application loading times.
- Improved protocol for enhanced data integrity
- Performance increases: For example, up to 6 GB/s maximum external (burst) data transfer rate for the 128 GB SDD drive
- Native Command Queuing allows the hard drive to have several write or read commands outstanding at the same time
- Supports the ATA Data Set Management Command (Trim Attribute) to help maintain your SSDs performance at "fresh-out-of-the-box" levels, and is specifically designed to run with Microsoft Windows 7\*.
- Includes installation kit that contains: 3.5" desktop drive bay adapter to 2.5" SSD adapter bracket, screws, installation guide, and warranty documentation.



# HP Solid State Drives (SSDs)

Boost the performance and robustness of your HP Business Desktop PC with an HP Solid State Drive



Product # QV063AA (128GB)

## Product Features and Benefits

- Take the worry out of storing your data with a hard drive with no moving parts
- Get faster transfer speeds and higher cell endurance with Intel NAND flash memory Multi Level Cell (MLC) components
- Significantly improve boot up, shut down and application loading times.
- Improved protocol for enhanced data integrity
- Performance increases: For example, up to 6 GB/s maximum external (burst) data transfer rate for the 128 GB SDD drive
- Native Command Queuing allows the hard drive to have several write or read commands outstanding at the same time
- Supports the ATA Data Set Management Command (Trim Attribute) to help maintain your SSDs performance at "fresh-out-of-the-box" levels, and is specifically designed to run with Microsoft Windows 7\*.
- Includes installation kit that contains: 3.5" desktop drive bay adapter to 2.5" SSD adapter bracket, screws, installation guide, and warranty documentation.



# PCIe x4 M.2 128GB SSD Card

## HP Turbo Drive

Reduce boot up, calculation, and graphics response times and revolutionize how your HP station handles large files with the HP M2 Drive, a remarkably affordable and innovative PCIe-based SSD storage solution.



Product # J5V07AA (128 GB)

### Product Features and Benefits

- Handle large files and reduce your work time from hours to minutes with a solid state drive powered by ultra-fast PCIe SSD components
- Access up to 2x the storage performance at a cost similar to today's standard SATA SSD with this innovative solution
- Reduce bottlenecks by connecting directly to the PCIe infrastructure
- 128GB (high costs for larger, but planned for 256GB in 2015)
- Only supports one card in the system
- Limited system support with 705 platform and soon for 800SFF/TWR



# Intel® Pro 1500 180 GB SATA SED Opal1 Solid State Drive (SSD)

Boost the performance and robustness of your HP Business Desktop PC with an HP Solid State Drive



Product # G4M04AA (180GB)

## Product Features and Benefits

- Take the worry out of storing your data with a hard drive with no moving parts
- Get faster transfer speeds and higher cell endurance with Intel NAND flash memory Multi Level Cell (MLC) components
- Significantly improve boot up, shut down and application loading times.
- Improved protocol for enhanced data integrity
- Achieves sequential read rates of up to 540-megabyte (MB)/sec and sequential write rates of up to 490-megabytes (MB)/sec
- Native Command Queuing allows the hard drive to have several write or read commands outstanding at the same time
- Supports the ATA Data Set Management Command (Trim Attribute) to help maintain your SSDs performance at "fresh-out-of-the-box" levels, and is specifically designed to run with Microsoft Windows 7\*.
- Includes installation kit that contains: 3.5" desktop drive bay adapter to 2.5" SSD adapter bracket, screws, installation guide, and warranty documentation.





# HP Desktop Mini 500GB HDD/ I/O Module

Add an extra hard drive to your HP Desktop Mini PC and enable compatibility with your existing and legacy peripherals with the HP Desktop Mini 500GB HDD/I/O Module.



1



2



3

Product # K9Q82AA

## Product Features and Benefits

- Expand storage, plus PS/2 and Serial port
- Sleek and slim HP specific design easily integrates this expansion option into your HP Mini environment
- Transfer Rate (Maximum): Up to 6 Gb/s
- Host Interface: USB 3.0 Type A female connector
- Rotational Speed: 7200 rpm
- VESA mount: Yes, 100mm
- Compatibility HP 260 Desktop Mini, HP ProDesk 400 Desktop Mini, HP ProDesk 600 Desktop Mini, HP EliteDesk 705 Desktop Mini, HP EliteDesk 800 Desktop Mini



# Optical Devices



# HP Optical Devices

Price



HP SATA 16x  
SuperMulti Drive,  
QS208AA



HP Desktop Mini  
DVD Super Multi-  
Writer ODD  
Module  
K9Q83AA



HP USB External  
DVDRW Drive,  
F2B56AA



HP Slim 8X SATA  
SuperMulti Drive,  
QS209AA



HP Slim BDXL  
Blu-Ray Writer,  
E0X94AA



# New AMO Kits – Storage



## What is It?

- HP Desktop G2 9.5mm Slim DVD-Writer Drive (400 /600/705/800/TWRs/SFFs)

## HP 9.5mm G2 Slim Drives

## Customer Benefits

- New Slim Size ODD drives
- Same performance as current Slim Drives
- Same SATA interface as current Slim Drives
- Full OS Support

## AMO Part #s

- AMO Kit # N1M42AA

# New AMO Kits – Storage



## HP 9.5mm G2 Slim Drives

### What is It?

- HP Desktop G2 9.5mm Slim DVD-Writer Drive (400 /600/705/800/TWRs/SFFs)
- HP 9.5mm AIO 705/800 G2 Slim DVD-ROM Drive
- HP 9.5mm EliteOne 705/800 G2 Slim SuperMulti DVD Writer Drive
- HP 9.5mm EliteOne 705/800 G2 Slim SATA BDXL Blu-Ray Writer

### Customer Benefits

- New Slim Size ODD drives
- Same performance as current Slim Drives
- Same Sata interface as current Slim Drives
- Full OS Support

### AMO Part #s

- AMO Kit 705/800 AIO DVD-ROM Drive# N3S09AA
- AMO Kit 705/800 AIO DVD Writer# N3S10AA
- AMO Kit 705/800 AIO BDXL Blu-Ray Writer # N3S11AA



# New AMO Kits – Storage



**HP 9.5mm AIO 600 G2 Slim  
DVD-ROM Drive**

**HP 9.5mm AIO 600 G2 Slim  
SuperMulti DVD Writer Drive**

**HP 9.5mm AIO 600 G2 Slim  
SATA BDXL Blu-Ray Writer**

## **What is It?**

- New HP 9.5mm AIO 600 G2 Slim DVD-Rom;
- HP 9.5mm AIO 600 SuperMulti DVD Writer;
- HP 9.5mm AIO 600 BDXL Blu-Ray Writer Optical Drive

## **Customer Benefits**

- New Slim Size ODD drives
- Same performance as current Slim Drives
- Same SATA interface as current Slim Drives
- Full OS Support

## **AMO Part #s**

- AMO Kit DVD-Rom # P1N65AA
- AMO Kit SuperMulti DVD Writer # P1N66AA
- AMO Kit BDXL Blu-Ray Writer # P1N67AA



# HP SATA 16x SuperMulti Drive

Now you can write to all DVD formats including DVD-RAM, burn your own disc labels from right inside your DVD drive and store up to 8.5 GB of data or record up to 4 hours of DVD-quality video – all with the HP SATA SuperMulti drive.



Product # QS208AA

## Product Features and Benefits

- Store up to 8.5 GB of data or record up to 4 hours of DVD-quality video
- Write to all DVD formats including DVD-RAM
- Fastest recordable technology available today for DVD burning
- Create DVD discs that can be played on most set-top DVD players and DVD-ROM drives
- Brings quality and affordability to the creation of video, audio, still imagery, and text on high-capacity media
- Permits recording, erasing, and re-recording of CD-RW, DVD+RW, DVD-RW and DVD-RAM discs up to 1,000 times
- Includes Roxio Easy Media Creator and Corel WinDVD SD software.



# HP Desktop Mini DVD Super Multi-Writer ODD Module

Add a DVD Super-Multi Writer to your HP Desktop Mini PC with HP Desktop Mini DVD Super Multi-Writer ODD Module.<sup>1</sup>

## Product Features and Benefits

- Sleek and slim HP specific design easily integrates this expansion option into your HP Mini environment
- Disc capacity Up to 8.5 GB DVD double-layer or 4.7 GB standard single-layer
- Write/Read speeds<sup>2</sup> DVD-RAM Up to 5X
- Power Source USB 3.0 Type A female connector
- VESA mount Yes, 100mm
- Compatibility HP 260 Desktop Mini, HP ProDesk 400 Desktop Mini, HP ProDesk 600 Desktop Mini, HP EliteDesk 705 Desktop Mini, HP EliteDesk 800 Desktop Mini



Product # K9Q83AA

Picture 1: HP ProDesk 400 Desktop Mini in HP Security/ Dual VESA Sleeve stacked with DVD Super Multi-Writer ODD Expansion Module and HP 500GB HDD/ I/O Expansion Module, left facing

Picture 2: DVD Super Multi-Writer ODD Expansion Module, left facing top

Picture 3: DVD Super Multi-Writer ODD Expansion Module, left facing bottom

1. The DVD-RAM cannot read or write to 2.6 GB Single Sided/5.2 GB Double Sided – Version 1.0 media.
2. Check the QS for full specs





# HP USB External DVDRW Drive (for Mini)

With the HP External USB Optical Drive, any available USB port on your notebook or Mini becomes a ticket to optical storage. Simply connect the drive with the included USB cable, and get immediate read/write access to your optical media.



Product # F2B56AA

## Product Features and Benefits

- Write to or access large files, media or music from CDs or DVDs
- Connect easily through a USB 2.0 port
- Lightweight, compact design stores easily into a carrying case or backpack

# HP Slim 8X SATA SuperMulti Drive BLK

Now store up to 8.5 GB of your data or record up to 4 hours of DVD-quality video on dual-layer DVD±R media with the HP Slim SuperMulti DVD Writer Drive.



Product # QS209AA

## Product Features and Benefits

- Store up to 8.5 GB of data or record up to 4 hours of DVD-quality video
- Fastest recordable technology available today for DVD burning
- Features the latest in double layer recording technology
- Allows users to create DVD discs that can be played on most set-top DVD players and DVD-ROM drives
- Brings quality and affordability to the creation of video, audio, still imagery, and text on high-capacity media
- Permits recording, erasing, and re-recording of CD-RW, DVD+RW and DVD-RW discs up to 1,000 times and DVD-RAM discs up to 10,000 times
- Includes Corel WinDVD SD and Roxio Business Creator software



# HP Slim BDXL Blu-Ray Writer Drive

Quickly and easily back up your data and create and edit professional-quality HD video content with the HP Slim Blu-ray BDXL SATA Drive and integrated CyberLink Media Suite. Enjoy read-write capabilities with CDs, DVDs, and Blu-ray discs.<sup>1,2</sup>



Product # E0X94AA

## Product Features and Benefits

- Get fast data transfer speeds from the dedicated bandwidth of a SATA connection. The slim design fits into a range of HP Business Desktop PCs.
- Quickly and easily backup data, copy files for easy transport, and create music, movie, and multimedia projects with integrated CyberLink Media Suite software tools.<sup>2</sup>
- Now you can use one drive for many of your current and legacy discs. Quadruple-layer technology reads from and writes to Blu-ray BD-R quad-layer discs and a range of CD and DVD formats.<sup>1,2,3</sup>

# Security Solutions



# HP Security Solutions

Price



NEW

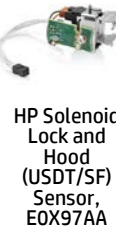

# New AMO Kits – Chassis Specific Devices



## HP Business PC Security Lock V2 Kit

### What is It?

- HP Business PC Security Lock V2 Kit



### Customer Benefits

- Only one lock needed to support both the platform, monitor, and cables
- MasterLock support
- Supports both SFF and Towers

### AMO Part #

- AMO Kit # N3R93AA

# HP (2009) USDT Rear Port Controller Cover

Prevent access to ports at the back of your HP Compaq Business Desktop with a rear port controller cover.



Product # VN571AA

## Product Features and Benefits

- Prevent access to rear ports
- Enhances security and convenience

# HP Desktop Mini Security/Dual VESA Sleeve

Wrap your HP Desktop Mini PC in the HP Desktop Mini Security/Dual VESA Sleeve to securely mount your PC behind your display, position your solution on a wall, and lock it down with the optional HP Ultra-Slim Cable Lock.



1



2

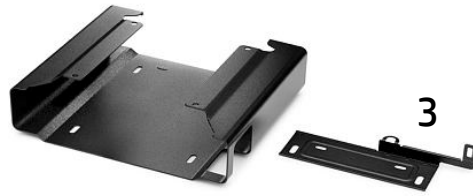

3

Product # G1K22AA

## Product Features and Benefits

- Sleek and slim HP specific design
- Retain connectivity - Enjoy easy access to all of your ports with a Sleeve and cutouts designed exclusively for your HP Desktop Mini PC.
- VESA mount Yes, 100mm
- Compatibility HP 260 Desktop Mini, HP ProDesk 400 Desktop Mini, HP ProDesk 600 Desktop Mini, HP EliteDesk 705 Desktop Mini, HP EliteDesk 800 Desktop Mini





# HP 2014 Solenoid Lock & Hood Sensor (MT)

Help protect your PC from unauthorized tampering or theft with a hood sensor and chassis cover lock. Integrated software alerts admins to tampering or removal, and allows you to activate and deactivate the lock from a central or remote location.

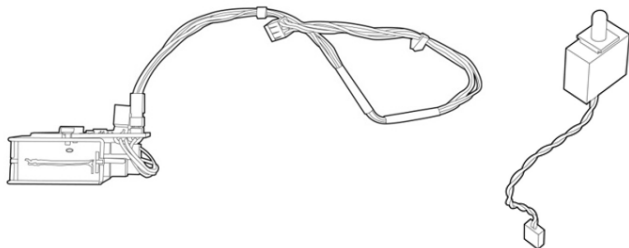

Product # J6L42AA

## Product Features and Benefits

- Dual-function hardware design acts as both a hood sensor and a chassis cover lock.
- Integrated software alerts administrators to attempted tampering or removal, and allows the lock to be activated or deactivated from a central or remote location\*

\*Internet access required and not included



# HP 2014 Solenoid Lock & Hood Sensor (SFF)

Help protect your PC from unauthorized tampering or theft with a hood sensor and chassis cover lock. Integrated software alerts admins to tampering or removal, and allows you to activate and deactivate the lock from a central or remote location.

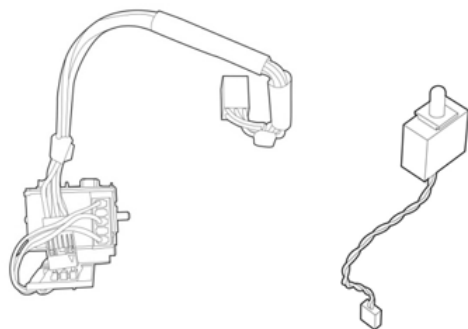

Product # J6L43AA

## Product Features and Benefits

- Dual-function hardware design acts as both a hood sensor and a chassis cover lock.
- Integrated software alerts administrators to attempted tampering or removal, and allows the lock to be activated or deactivated from a central or remote location\*

\*Internet access required and not included



# HP Solenoid Lock and Hood (TWR) Sensor

Help protect your PC from unauthorized tampering or theft with a hood sensor and chassis cover lock. Integrated software alerts admins to tampering or removal, and allows you to activate and deactivate the lock from a central or remote location.<sup>1</sup>



Product # E0X96AA

## Product Features and Benefits

- Help deter theft with a hardware cover lock that prevents access to the interior of the chassis.
- Manage the integrated software from a central or remote location<sup>1</sup>, and get alerts to potential tampering of chassis removal.

# HP Solenoid Lock and Hood (USDT/SFF) Sensor

Help protect your PC from unauthorized tampering or theft with a hood sensor and chassis cover lock. Integrated software alerts admins to tampering or removal, and allows you to activate and deactivate the lock from a central or remote location.<sup>1</sup>

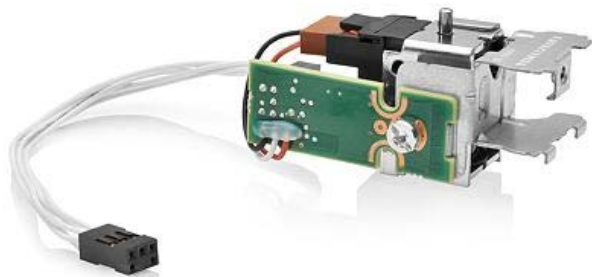

Product # E0X97AA

## Product Features and Benefits

- Help deter theft with a hardware cover lock that prevents access to the interior of the chassis.
- Manage the integrated software from a central or remote location<sup>1</sup>, and get alerts to potential tampering of chassis removal.

# HP Chassis Security Kit

Prevent access to or removal of internal components like memory, hard drive, and power supply, particularly designed for the education market.



Product # AR639AA

## Product Features and Benefits

- Protect your investment and help keep the system up and running by:
- Safeguarding the memory and hard drive with a metal bay filler
- Securing the power supply with two screws
- Preventing cable disconnection
- Locking down the front bezel so that internal components cannot be removed

# HP UltraSlim Cable Lock Kit

Secure your HP Ultrabook™ or laptop PC quickly and easily with the HP UltraSlim Keyed Cable Lock



Product # H4D73AA ( replacing BV411AA; MP leveraged)

## Product Features and Benefits

- The slimmest lock available from HP, the HP UltraSlim Keyed Cable Lock is designed for the ultra-slim profile of HP Ultrabook™ PCs and offers compatibility with any HP notebook with a security lock slot.
- A 5.9 ft (1.80 m) vinyl-coated, galvanized aircraft-grade steel cable loops around any secure object and then attaches to the notebook with a push-button locking mechanism and a unique key (including a spare key).
- Swivel and adjust the cable 360 degrees to wherever you need to tether your PC to a table, desk, or other device.

# HP Business Security Lock Kit

Protect your HP Business PC from tampering or theft in public locations by locking-down peripherals such as mice, keyboards, monitors or USB security devices and preventing the removal of the PC chassis cover.



Product # PV606AA (MP leveraged)

## Product Features and Benefits

- Secure your HP Business PC in public locations
- Help prevent removal of peripherals and PC chassis cover
- Monitor lock and key support
- Optional cable trap available to secure monitor cable and physically connect system to an anchor point
- Helps secure internal system components
- Deterrent to unauthorized removal of peripherals or PC
- Physical security is a key component of an overall security plan



# HP (2013) SFF Wall Mount/Security Sleeve

Physically mount and secure your 2013 and legacy HP Small Form Factor Business Desktop PC onto a wall or underneath a desk with the HP (2013) SFF Wall Mount/Security Sleeve.



Product # FOK75AA (replacing VN570AA)

## Product Features and Benefits

- Mount your desktop on a wall or beneath your desk
- Enhances security and convenience
- Frees up valuable desktop space



# Workspace Enhancements



# HP Chassis and Monitor Accessories

Price



HP Desktop Mini Rack Mount Tray G1K21AA



HP (10 Sets) 400/600/800 TWR/SFF/800 USDT Bezel Kits



HP DM Chassis Tower Stand G1K23AA



HP 2009 (USD) Tower Stand, VN568AA



HP 2009 (SFF) Tower Stand, VN569AA

E1C67AA  
E1C66AA,  
E3F27AA,  
E3F28AA

400 G2,  
700 G1  
J4R48AA,



Thin Client Mount Kit, E5J35AA



HP LCD Speaker Bar (Black), NQ576AA/AT



HP Quick Release, EM870AA/AT



HP ProDisplay Companion Stand, J7V21AA



HP Integrated Work Center Stand for Mini/TC, G1V61AA



HP Integrated Work Center Stand for USD, E8H16AA\*



HP SFF Integrated Work Center v3, F2P06AA Dec-15



HP ProOne 400 Recline & Height Adj Stand, KOA70AA



HP Height Adjustable and Reclining Stand, C1N43AA



HP Adjustable Display Stand, AW663AA



HP Single Monitor Arm, BT861AA/AT



HP Display and Notebook Stand, E8G00AA

HP Adjustable Dual Display Stand, AW664AA



HP Desktop 65w Mini Power Supply Kit L2X04AA



# HP 2x2 SFF Stand



## Product Features and Benefits

**Free up valuable desk space**

**Support the HP ProDesk 400 G2.5 SFF**

**Product # N4G86AA**



# HP DT Mini/Thin Client Mount

Customize an altogether better solution with the HP PC Mounting Bracket for Monitors, which lets you attach your HP Desktop Mini, HP Chromebox, or select HP Thin Client directly behind select HP Z Displays and EliteDisplays.<sup>1</sup>



Product # N6N00AA

## Product Features and Benefits

Maximize your available work area with a single-footprint solution. Simply attach the bracket to the back of your display, and your PC platform to the bracket. It's that easy!

Retain the comfort features of your HP EliteDisplay or HP Z Display.<sup>1</sup> The bracket doesn't interfere with the monitor's height adjustment, tilt, swivel or pivot settings.

Reduce cable clutter and keep a tidier workspace with a short DisplayPort cable

Easily and securely attach the monitor and PC with one thumb screw

Compatible with 2015 EliteDisplays and select Z Displays<sup>1</sup>

Compatible with 100 x 100 mm VESA mount

700 mm short DP cable

# HP Desktop Mini Rack Mount Tray Kit

Put your HP Desktop Mini PCs to work behind the scenes with HP Desktop Mini Rack Mount Tray Kit, which holds up to eight PCs and fit into the HP 100kg Sliding Shelf.<sup>1</sup>



Product # G1K21AA

## Product Features and Benefits

- **Maximum capacity** Holds up to eight PCs and fit into the HP 100kg Sliding Shelf.<sup>1</sup>
- **Rack configuration** 2 Kits populate one entire shelf
- **Additional physical security measure**
- **Additional storage option**
- **Also accommodates the Lenovo Tiny, can aid in transitioning customers who already have existing units over to a Mini**
- **Compatibility** HP 260 Desktop Mini, HP ProDesk 400 Desktop Mini, HP ProDesk 600 Desktop Mini, HP EliteDesk 705 Desktop Mini, HP EliteDesk 800 Desktop Mini, ThinkCentre m53 Tiny Desktop, ThinkCentre m73 Tiny Desktop, ThinkCentre m83 Tiny Desktop, ThinkCentre m93 Tiny Desktop

1. Each Kit holds eight HP Desktop Mini PCs. Up to two Kits will fit into the HP 100kg Sliding Shelf, sold separately. To leave room for cabling, all eight slots may not be available in each kit.



# HP DM Chassis Tower Stand

Tower Stand specially designed to convert the Mini into a Tower Configuration thereby freeing valuable desk space and increases productivity.

## Product Features and Benefits

- Free up valuable desk space



Product # G1K23AA

# HP 2009 (Black) USDT Tower Stand

Tower Stand specially designed to convert the Ultra Slim into a Tower Configuration thereby freeing valuable desk space and increases productivity.

## Product Features and Benefits

- Free up valuable desk space



Product # VN568AA

# HP 2009 (SFF) Tower Stand

Tower Stand specially designed to convert the SFF into a Tower Configuration thereby freeing valuable desk space and increases productivity.

## Product Features and Benefits

- Free up valuable desk space



Product # VN569AA



# New AMO Kits – Chassis Specific Devices

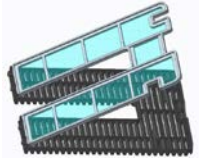

## What is It?

- HP EliteDesk 800 G2 SFF Bezel/Dust Filter Kit ; 3 SFF Pack Dust Filter Kit
- HP EliteDesk 800 G2 Tower Bezel/Dust Filter Kit ; 3 Tower Pack Dust Filter Kit

## Customer Benefits

- New for 800 G2 SFF and Tower Platforms
- Helps remove dust getting into platform chassis
- Easy filter install/remove with the front bezel
- Additional 3 Pack AMO kit for additional filters needed

## AMO Part #

- AMO Kit # P1N69AA- HP EliteDesk 800 G2 SFF Bezel/Dust Filter Kit
- AMO Kit # P1N71AA - HP EliteDesk 800 G2 Tower Bezel/Dust Filter Kit

HP EliteDesk 800 G2 SFF  
Bezel/Dust Filter; HP  
EliteDesk 800 G2 SFF 3  
Pack Dust Filters ; HP  
EliteDesk 800 G2 Tower  
Bezel/Dust Filter HP  
EliteDesk 800 G2 Tower 3  
Pack Dust Filters



# New AMO Kits – Chassis Specific Devices

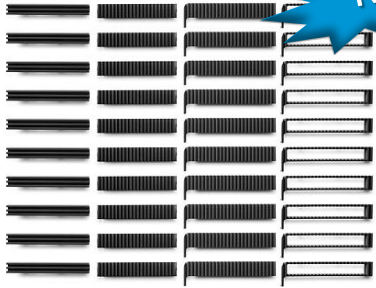

New

## HP (10 Sets) Bezel Support Kit

### What is It?

- Blank Bezel support kits for G2 platforms

### Customer Benefits

- Bulk kits for those users who need a number of blank bezels
- Each support kit supports the ODD blank bezel of each type of platform

### AMO Part #

- AMO Kit # N1M44AA - HP (10 Sets) 600/705 G2 MicroTower Bezel Support Kit
- AMO Kit # N7H10AA - HP (10 Sets) 600/705/800 G2 SFF Bezel Support Kit
- AMO Kit # P1N74AA HP (10 Sets) EliteDesk 800 G2 Tower Bezel Support Kit

# HP (10 Sets) 600/800 TWR Bezel Support Kit

Help secure the fit of your after-market optical disk drive into your desktop chassis with the HP (10 Sets) 600/800 TWR Bezel Support Kit.



Product # E1C66AA

## Product Features and Benefits

- Specifically designed to fit your form factor, seal the installation, and maintain the aesthetic lines of your PC.
- The 10-pack simplifies easy mass deployments.
- Each support kit contains 40 screws (4 for each drive) for supporting additional 2.5" drives.

# HP (10 Sets) 400 G1 Bezel Support Kit

Help secure the fit of your after-market optical disk drive into your desktop chassis with the HP (10 Sets) 400 Bezel Support Kit.

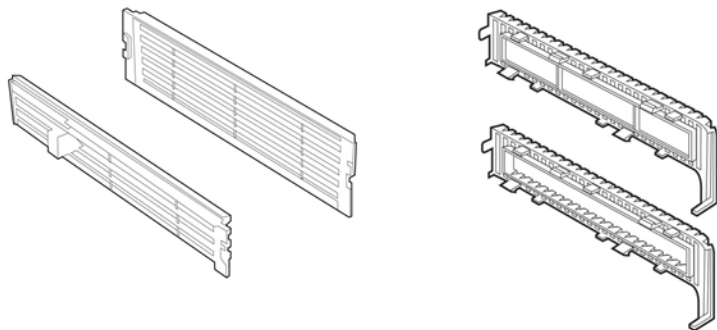

Product # E1C67AA

## Product Features and Benefits

- Specifically designed to fit your form factor, seal the installation, and maintain the aesthetic lines of your PC.
- The 10-pack simplifies easy mass deployments.
- Each support kit contains 40 screws (4 for each drive) for supporting additional 2.5" drives.

# HP (10 Sets) 600/800 SFF Bezel Support Kit

Help secure the fit of your after-market optical disk drive into your desktop chassis with the HP (10 Sets) 600/800 SFF Bezel Support Kit.



Product # E3F27AA

## Product Features and Benefits

- Specifically designed to fit your form factor, seal the installation, and maintain the aesthetic lines of your PC.
- The 10-pack simplifies easy mass deployments.
- Each support kit contains 40 screws (4 for each drive) for supporting additional 2.5" drives.

# HP (10 Sets) 800 USDT Bezel Support Kit

Help secure the fit of your after-market optical disk drive into your desktop chassis with the HP (10 Sets) 600/800 USDT Bezel Support Kit.



Product # E3F28AA

## Product Features and Benefits

- Specifically designed to fit your form factor, seal the installation, and maintain the aesthetic lines of your PC.
- The 10-pack simplifies easy mass deployments.

# HP (10 Sets) 400 G2/700 G1/ 705 G1 Bezel Support Kit

Quickly and easily install an after-market optical disk drive into your HP Business Desktop chassis with the HP (10 Sets) 400 G2/700 G1/ 705 G1 Bezel Support Kit.

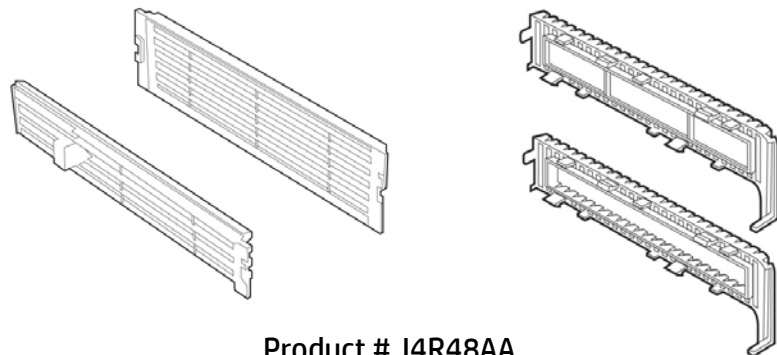

Product # J4R48AA

## Product Features and Benefits

- Help ensure a secure fit with a Kit specifically designed to fit your HP form factor, seal the installation, and maintain the aesthetic lines of your PC
- Simplify mass deployments with a 10-pack

# HP Thin Client Mount Kit

Attach your HP Thin Client or USDT PC to the back of select HP Z Displays and maintain optimal ergonomic adjustability with the HP Thin Client Mount Kit



Product # E5J35AA (WS leveraged)

## Product Features and Benefits

- Unique solution for mounting HP Thin Clients and USDT PCs to the back of 24-, 27-, and 30-inch diagonal HP Z Displays
- No screen size limits to creating a compact "all-in-one" workspace with a thin client or USDT.
- Quickly assemble by attaching the HP Thin Client or USDT PC to the Kit's VESA plate



# HP Quick Release

HP offers a variety of optional products (each sold separately) designed to complement our monitors and enhance the overall computing experience. The HP LCD Monitor Quick Release is the newest option designed for use with 100 mm VESA-compatible flat panel monitors.



Product # EM870AA/AT

## Product Features and Benefits

- **Storefronts/kiosks:** Mount flat panel monitors for easy viewing and add touchscreens for interactivity.
- **Trade shows:** Securely mount LCD TVs or monitors in common areas and quickly remove them for safekeeping at the end of the day.
- **Front office environments:** Minimize desk space requirements with wall or swing-arm mounting of monitors in reception areas.
- **Training labs:** Mount a monitor directly on a 100 mm VESA-compatible PC such as the HP Compaq 8200 Elite USDT or an HP Thin Client for all-in-one convenience.
- **Medical/institutional settings:** Securely mount monitors in nursing stations and public areas.
- **Conference rooms:** Mount projectors (with 100 mm VESA-compliant pre-drilled holes) on ceilings, and monitors on walls or tables.



# HP ProDisplay Companion Stand

Low cost work center that integrates the Desktop Mini or Chromebox with a Monitor, Stand, and power brick into a compact, space-savings solution (another “Better Together” solution like Collie)



Product # J7V21AA

## Product Features and Benefits

- Mounts the Desktop Mini, USDT, t310, t410, t510, t520, or t620 on the back of a ProDisplay Monitor using a Quick Release and a stand
- Power brick sits in a holder on the bottom of the stand behind the neck
- Supports all ProDisplay models sold today.

# HP Integrated Work Center Stand for Desktop Mini / Thin Client

Designed to provide convenient access to the Desktop Mini and select Thin Clients\* to help maximize the use of limited desk space without compromising performance or productivity. It will support many HP 17 to 24-inch<sup>1</sup> diagonal LCD monitors (see compatibility list below), with VESA standard mounting brackets.



Product # G1V61AA

## Product Features and Benefits

- Make the most of small work spaces with an HP IWC Desktop Mini/Thin Client<sup>3</sup> that lets you create a compact desktop solution by combining a display<sup>1</sup> with an HP Desktop Mini or Thin Client\*.
- Use the 15.5mm screws (provided) to attach to the base of the stand
- Save time and work smarter with easy front access to your HP Desktop Mini or Thin Client's\* inputs, connectors, and power buttons.
- Run all of your cables through the guides, and secure the HP Desktop Mini's power brick out of the way on the back of the stand.
- Power brick tray for Desktop Mini keeps the power brick completely off the desk and out of the way.
- Find your best viewing position with adjustable height, tilt, and swivel adjustment settings.
- Built-in HP Quick Release enables easy installation and removal of monitor.



# HP Integrated Work Center Stand for USDT/TC

Maximize the use of limited desk space without compromising performance by accommodating USDTs or Thin Clients and most HP 17 to 24-inch diagonal LCD monitors\*, with VESA standard mounting brackets •



Product # E8H16AA

## Product Features and Benefits

Integrates your HP Ultra-slim Desktop PC or Thin Client1 and most HP 17 to 24-inch2 diagonal LCD monitors, allowing you to conveniently put the entire compact system configuration at your fingertips, saving valuable desktop space and making the most efficient use of space-constrained office environments

- Cable management clips help keep cables neatly dressed and concealed behind the stand
- Industry-standard VESA mounting holes enable high or low positioning of the USDT or Thin Client
- An adjustable stand with tilt, height and swivel lets you change positions throughout the day, helping you stay comfortable and productive
- Built-in HP Quick Release enables easy installation and removal of monitor



# HP Integrated Work Center (SFF) v3

Maximize your available work space with the stylish and innovative HP Integrated Work Center for Small Form Factors v3 (HP IWC SFF v3), designed to match the newest HP PC designs. Create a customized “all-in-one” solution by combining an HP Small Form Factor (SFF) Business Desktop PC or Workstation with an LED monitor up to 24 diagonal inches\*



Product # F2P06AA

## Product Features and Benefits

- Maximize your available work space with a customized “all-in-one” solution.
- Simply attach the monitor to the VESA mount, route the cables, and place the SFF on the back platform of the stand.
- Find your best viewing position with adjustable tilt, swivel, height adjustment, and pivot settings.
- Use the convenient slot at the base to manage cables and minimize clutter.
- Store the keyboard and mouse when not in use, in a built-in storage area in the base

# HP Desktop 65w Mini Power Supply Kit

At home or at work power your Mini with a certified/trustful solution



Product # L2X04AA

## Product Features and Benefits

- Compatible with Intel platforms only
- Localizations: ABB, ABU, UUZ, ABZ,ABT, ACQ
- Compatibility HP 260 Desktop Mini, HP ProDesk 400 Desktop Mini, HP ProDesk 600 Desktop Mini, HP EliteDesk 800 Desktop Mini



# HP ProOne 400 Recline & Height Adj Stand

Designed specifically for use with the HP ProOne 400 G1 All-in-One Business PCs, the HP ProOne 400 G1 All-in-One Height Adjustable and Reclining Stand gives you the freedom to create a unique space that works for you.



Product # K0A70AA

## Product Features and Benefits

- Create a single or multi-user all-in-one environment that complements your desktop, kiosk or lobby in the most space-constrained environments
- Easy-attach, industry-standard VESA mounting bracket
- Wide range of high and low tilt positions that bring your display into perfect view
- Vertically adjusts more than 4-inches
- Tilt angle reclines up to 60 degrees
- Built to withstand 10,000 cycles on lift and tilt mechanisms

# HP Height Adjustable and Reclining Stand

Designed specifically for use with the HP Compaq Pro 6300 All-in-One and HP Compaq Elite 8300 All-in-One Business PCs, the HP Height Adjustable and Reclining Stand gives you the freedom to create a unique space that works for you.



Product # C1N43AA



## Product Features and Benefits

- Create a single or multi-user all-in-one environment that complements your desktop, kiosk or lobby in the most space-constrained environments
- Easy-attach, industry-standard VESA mounting bracket
- Wide range of high and low tilt positions that bring your display into perfect view
- Vertically adjusts more than 4-inches
- Tilt angle reclines up to 60 degrees
- Rotates to landscape or portrait orientation
- Swivels from left and right 360 degrees
- Built to withstand 10,000 cycles on lift and tilt mechanisms





# HP Adjustable Display Stand (for notebook)

Turn your HP Business Notebook into an ergonomic and desktop-like solution supporting up to a 24 inch display. A dual-hinged, smooth-motion display stand allows for greater depth, height and tilt adjustment for maximum comfort



Product # AW663AA #AC3 (MP leveraged)

## Product Features and Benefits

- Supports up to 15.4-lb (7.0-kg) VESA mounting interface displays and accessories
- The dual-hinged, smooth-motion display stand allows for greater distance, height, and tilt adjustment for maximum comfort
- Aligns and secures the docking station to the stand and helps secure a connected docking station
- Organizes and hides accessory cables in a central location to help reduce clutter when connecting multiple devices

# HP Single Monitor Arm

The perfect desk accessory for your work life. Sleek and streamlined, the HP Single Monitor Arm is designed to complement the way you work.

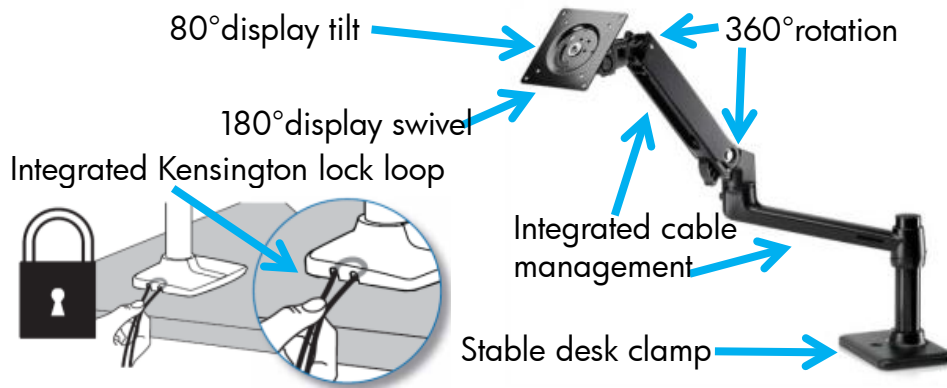

## Product Features and Benefits

- Space saving design frees up valuable desk space
- Supports up to one 24" diagonal display
- Flexible arm adjusts to your size, posture and work preference
- Locate the arm wherever it is most convenient for you on a desk, and secure then it with the adjustable clamp

Product # BT861AA



# HP Adjustable Dual Display Stand

Use two displays to maximize your productivity and optimize efficiency. Either or both displays can be rotated to landscape or portrait orientation, and the stand is depth-, height-, tilt-, and angle-adjustable so you can view both screens at eye-level as well as slightly facing each other



Product # AW664AA#AC3 (MP leveraged)

## Product Features and Benefits

- Use two external displays up to 24 inches in size at once to increase productivity.
- Either or both displays can be rotated to landscape or portrait orientation.
- Adjust your computer screen to a comfortable eye level - Dual-hinged design allows for greater depth, height and tilt and angle adjustment for maximum comfort.
- Keep your desktop clutter-free even when connecting multiple devices with the simple cable management channels on the back of the stand. (notebook, docking station, display and peripherals sold separately).

# HP Display and Notebook Stand

The perfect home base for the business traveler who is constantly on the go - turn your HP Business Notebook into a desktop solution supporting up to two displays (notebook display plus external display).



Product # E8G00AA#AC3 (replacing AW662AA #AC3 -  
MP leveraged)

## Product Features and Benefits

- HP Display and Notebook Stand, monitor stand spacer, documentation
- Supports up to 13.2 lbs. (6.0 kg) VESA mounting interface displays and accessories
- The dual-hinged, smooth-motion display stand allows for greater distance, height, and tilt adjustment for maximum comfort
- Adjusts the horizontal position of your display
- Adjusts for different-sized notebook PCs
- Aligns and secures the docking station to the stand
- Organizes and hides accessory cables in a central location to help reduce clutter when connecting multiple devices



# LAN Solutions



# HP Communication – Wireless/LAN

46 €

43 €

32 €



HPWLAN  
802.11 a/g/n  
2x2 DualBand  
PCIe x1,  
J5C51AA



Intel 7260  
802.11  
a/b/g/n PCIe  
x1 Card,  
F2P07AA



Intel Gigabit  
CT Desktop  
NIC, FH969AA



NIC -  
Broadcom  
NetXtreme  
Gigabit  
Ethernet,  
FS215AA



Intel Ethernet  
I210-T1 GbE  
NIC, E0X95AA



# New AMO Kits – Communications



## Intel 7265 802.11AC 2x2 DualBand PCIe x1 Card

### What is It?

- Intel 7265 802.11AC 2x2 DualBand PCIe x1 Card

### OS Support

- Windows 7/8.1/10

### Driver needed

- Yes, driver needed for Windows

### Customer Benefits

- Latest Intel technology
- New M.2 device technology
- 802.11AC DualBand technology support
- Both Wlan and Bluetooth support (Combo)

### AMO Part #

- AMO Kit # N4G85AA

# New AMO Kits – Communications



## **Broadcom BCM943228Z 802.11n 2x2 DualBand PCIe x1 Card**

### **What is It?**

- Broadcom BCM943228Z 802.11n 2x2 DualBand PCIe x1 Card

### **OS Support**

- Windows 7/8.1/10

### **Driver needed**

- Yes, driver needed for Windows

### **Customer Benefits**

- Latest Broadcom technology
- New M.2 device technology
- 802.11 N DualBand technology support
- Both Wlan and Bluetooth support (Combo)

### **AMO Part #**

- AMO Kit # N4M64AA



# HP WLAN 802.11 a/g/n 2x2 DualBand PCIe x1

Go wireless with dual-band 802.11n in a premium WLAN card

## Product Features and Benefits

- Wirelessly get online and connect to a wide range of devices at speeds up to 5 GHz.
- Enjoy solid performance on both bands with coexistence technologies that help reduce interference across the shared antenna



Product # J5C51AA

# Intel 7260 802.11 a/b/g/n PCIe x1 WLAN Card

Premium Wi-Fi performance from a multi-stream (2x2), dual-band PCIe card that delivers faster speeds than legacy cards. Plus, get integrated Intel® vPro™ Technology,<sup>1</sup> Intel® Wireless Display,<sup>2</sup> and Intel® business-class management features.



Product # F2P07AA

## Product Features and Benefits

- Get faster speeds than with previous-generation cards from the 5 GHz dual-band wireless. Help reduce power consumption with integrated Intel Power Optimizer.
- Connect to and manage a wide range of devices with integrated Intel technologies that deliver a total wireless solution.
- Get enterprise manageability, a simplified user interface, and advanced IT tools that help improve security, reduce complexity, and save IT time and money with Intel® PROSet/Wireless Enterprise Software.
- Enable IT administrators to streamline deployments and remotely manage wireless settings.
- Improve the return on your technology investment with the integrated management and security features of Intel® vPro™ Technology and Intel® Active Management Technology.<sup>1</sup> Remotely manage, monitor, and support PCs and help reduce threats.
- Access and project all of your content in HD<sup>3</sup> with one Wi-Fi connection.<sup>2</sup>
- Enjoy visually stunning 1080p video presentation, and Blu-ray and UltraViolet content with Intel® Wireless Display software.<sup>2</sup>
- Interact with the Windows 8 user interface and applications in real-time across Intel WiDi-enabled devices.

# Intel Gigabit CT Desktop NIC

Provides a complete end-to-end Gigabit solution from the server to the switch infrastructure and down to the desktop and workstation.



Product # FH969AA

## Product Features and Benefits

- End-to-end Gigabit solution
- Better network performance by alleviate congestion and removing bottlenecks
- High-performance connectivity solution for your LAN
- Interrupt moderation - significantly reduces CPU utilization and increases throughput
- ACPI, WOL, PXE - allows lower power consumption, remote wake and remote booting
- Advanced Cable diagnostics - dynamically tests and reports network problems (interrupts, error rate, cable length) and automatically compensates for cable issues
- PCI-E v1.0a compliant
- Optimized transmit and receive queues
- Support for ACPI WOL (wake on LAN), Magic Packet, and OOB WOL.
- A large 48Kbyte per port On-Chip memory



# NIC - Broadcom NetXtreme Gigabit Ethernet

The Broadcom NetXtreme line of Gigabit Ethernet products provide a complete end-to-end Gigabit solution from the server and server backbone to the switch infrastructure and now down through to the desktop and workstation.



Product # FS215AA

## Product Features and Benefits

- High-performance connectivity solution for your LAN. No rewiring expenses - runs perfectly on virtually all existing CAT-5 cabling
- Better network performance by alleviating congestion and removing bottlenecks
- ACPI, WOL, PXE - allows lower power consumption, remote wake and remote booting
- Advanced Cable diagnostics - dynamically tests and reports network problems (interruptions, error rate, cable length) and automatically compensates for cable issues
- Supports 802.3ad link aggregation, GEC/FEC, and Smart Load Balancing
- Failover - Smart Load Balancing allow heterogeneous, mixed speed failover



# Intel Ethernet I210-T1 GbE NIC Card

Enjoy Gigabit Ethernet networking that's designed for optimal performance, and with the environment in mind. Get Audio Video Bridging (AVB) support and efficient power management in a low-halogen single-port PCI-Express Gigabit Ethernet adapter.



Product # E0X95AA (replacing FS215AA)

## Product Features and Benefits

- Synchronize, buffer, and queue streams for time-sensitive communication requirements with Audio Video Bridging (AVB).
- Get Error Correcting Memory (ECC) protection and improved data reliability from four transmit and four receive queues that manage packets and reduce latency to optimize multi-core processing performance.
- Help reduce Ethernet connection power consumption with a card that meets the IEEE802.3az Energy Efficient Ethernet standard to switch to a low power idle state when not in use.



# Mini Accessories (Recap)





# Mini Ecosystem

## Expansion Modules



External Optical Disk Drive



External Hard Disk Drive



Legacy I/O Ports

## Security and Mounting Kits



Dual VESA security sleeve



Quick-release  
mounting bracket



Rack mounting to centrally  
store multiple minis

## Display Productivity

Pro Display  
Mounting Arms  
and stands

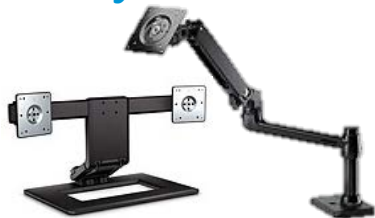

HP Docking  
Monitor



Pro Display  
Companion  
Stand



Integrated Work  
Centre





# HP Desktop Mini Security/Dual VESA Sleeve

Wrap your HP Desktop Mini PC in the HP Desktop Mini Security/Dual VESA Sleeve to securely mount your Mini behind your display, position your solution on a wall, and lock it down with the optional HP Ultra-Slim Cable Lock.

## Key Selling Points

- **Create a secure Mini solution** - Wrap your HP Desktop Mini PC to **securely mount** your PC **behind your display**, position your solution **on a wall**, and **lock it down** with the optional HP Ultra-Slim Cable Lock
- **Retain connectivity** - Enjoy **easy access** to all of your **ports** with a Sleeve and cutouts designed exclusively for your HP Desktop Mini PC.



Product # G1K22AA

## Benefits & Features:

Allows for “sandwich mounting” between

1. Monitor → Mini wall/
  2. Monitor → Mini expansion module wall
  3. Desk → Sleeve Mini expansion module
- Can lock with Universal Lock, and padlock – still access to all ports

**Security Sleeve locking ability is HP Unique**

## User scenarios:

### Healthcare: Hospital



Use the Security/ Dual VESA Sleeve to mount a Mini behind a monitor and attach an additional expansion sleeve freeing up limited CPU space in patient rooms or on mobile carts.

### Finance: Financial Trader



Use the Security/ Dual VESA Sleeve under a desk, securely mounting it to the furniture and being able to also mount an expansion sleeve eliminating clutter in your work space.



# HP Desktop Mini Rack Mount Tray Kit

Put your HP Desktop Mini PCs to work behind the scenes with HP Desktop Mini Rack Mount Tray Kit, which holds up to eight Minis and fit into the HP 100kg Sliding Shelf.<sup>1</sup>

## Key Selling Point

- **Help secure your data center** - Use the Kit with your existing HP 100kg Sliding Shelf<sup>1</sup> for a **secure**, easy-to-use, and durable solution that allow s you to **store** your HP Desktop Mini PCs inside a closet or storage area.



\*1. Each Kit holds eight HP Desktop Mini PCs. Up to two Kits will fit into the HP 100kg Sliding Shelf, sold separately. To leave room for cabling, all eight slots may not be available in each kit.

Product # G1K21AA

## Need to Knows:

- 1 kit supports 8 Minis
- 2 Kits populate one entire shelf
- User must purchase server tray and rack separately

## Benefits & Features:

- Additional physical security measure
- Additional storage option
- Also accommodates the Lenovo Tiny, can aid in transitioning customers who already have existing units over to a Mini

## User scenarios:



### Secure/ Government office environment: Lab

Store/secure Minis in an out of sight location like a server room or closet to add an additional layer of physical security or free up more space in your work environment.

# HP Desktop Mini DVD Super Multi-Writer ODD Module

Add a DVD Super-Multi Writer to your HP Desktop Mini PC with HP Desktop Mini DVD Super Multi-Writer ODD Module.<sup>1</sup>

## Key Selling Points

- **Easy assembly** – Slide and hook the Module to the Mini with the included screws, connect with the included USB 2.0 cable, and use [the integrated VESA mount](#) to place the Module wherever you need it.
- **Make is secure** - Lock the Module to your HP Desktop Mini PC or a desk or table with the optional HP Ultra-Slim Cable Lock.



Product # K9Q83AA

## Benefits & Features:

- Have access to ODD drive to read or write information
- Sleek and slim HP specific design easily integrates this expansion option into your HP Mini environment
- Also has VESA mounting
- Can be physically be secured a Mini or another expansion module

[Thinnest option on the market](#)

## User scenarios:

### Education: Classroom



Use the ODD expansion module in a classroom for material that can be loaded off of a CD, or show material saved on a DVD to students without compromising your space.

### Knowledge Worker: Designer



Write and load information on a CD or DVD with the ODD expansion module that can be mounted under a desk with a Security/dual VESA Sleeve and a Mini keeping your workspace clean.



# HP Desktop Mini I/O Module

Keep working with your existing peripherals and add legacy ports to your HP Desktop Mini PC with the HP Desktop Mini I/O Module.

## Key Selling Points

- **Easy assembly** – Slide and hook the Module to the PC with the included screws, connect with the included USB 2.0 cable, and use the **integrated VESA mount** to place the Module wherever you need it.
- **Make is secure** - Lock the Module to your HP Desktop Mini PC or a desk or table with the optional HP Ultra-Slim Cable Lock.



Product # K9Q84AA

## Benefits & Features:

- Have access to PS/2, Serial port and 2 additional USB 2.0 ports
- Sleek and slim HP specific design easily integrates this expansion option into your HP Mini environment
- Also has VESA mounting
- Can be physically be secured a Mini or another expansion module

**Thinnest option on the market**

## User scenarios:

### Finance: Bank Teller



Support legacy peripherals with PS/2 and a serial port with a physically secure expansion option that can be locked to a Mini and within your working environment.

### Retail: Public Kiosk



Use additional USB ports and legacy peripherals with the I/O expansion module that can be safely attached to a Mini. Great for a customer facing location with its sleek design that seamlessly integrates with the Mini.



# HP Desktop 65w Mini Power Supply Kit

At home or at work power your Mini with a certified/trustful solution



Product # L2X04AA

## Product Features and Benefits

- Compatible with Intel platforms only
- Localizations: ABB, ABU, UUZ, ABZ,ABT, ACQ
- Compatibility HP 260 Desktop Mini, HP ProDesk 400 Desktop Mini, HP ProDesk 600 Desktop Mini, HP EliteDesk 800 Desktop Mini



# HP Desktop Mini Accessories Compatibility

Accessory	HP Desktop Mini Rack Mount Tray Kit	HP Desktop Mini Security Dual/VESA Sleeve	HP Desktop Mini DVD Super Multi-Writer ODD Expansion Module	HP Desktop Mini 500GB HDD/I/O Expansion Module	HP Desktop Mini I/O Expansion Module	EliteDisplay/ProDisplay  (Up to 24 in)	HP Monitor Quick Release Bracket	HP Single Monitor Arm	Integrated Work Center
HP Desktop Mini Rack Mount Tray Kit									
HP Desktop Mini Security Dual/VESA Sleeve			✓	✓	✓	✓	✓	✓	✓ (If mounted behind)
HP Desktop Mini DVD Super Multi-Writer ODD Expansion Module		✓		✓	✓	✓	✓	✓	✓ (If mounted behind)
HP Desktop Mini 500GB HDD/I/O Expansion Module		✓	✓		✓	✓	✓	✓	✓ (If mounted behind)
HP Desktop Mini I/O Expansion Module		✓	✓	✓		✓	✓	✓	✓ (If mounted behind)

Up to 2 Expansion Modules can be used together. This applies to the 260, 400, and G2 705, and 800 in 2015.



# Software Solutions





# SecureDoc Drive Encryption



# WINMAGIC-HP BATTLE CARD

## HP DRIVE ENCRYPTION (Pre-install)

**Elevator Pitch** - As part of HP Client Security, HP Drive Encryption is pre-installed on all new HP commercial notebooks and desktops. It enables individuals, SMB and Enterprise customers to implement Data Encryption on their devices, providing pre-boot authentication, full support for Opal Self Encrypting Drives, HP System recovery features and encryption key back-up.

### Current Market Challenges

- 10% - 15% of laptops are lost by enterprises each year
- The average cost of a data breach is \$5.5M\*
- Approx. 60% of sensitive enterprise data resides in some form mobile devices
- Privacy and security regulations force companies not only to disclose data breaches if laptops, USB flash drives are lost or stolen but also incur penalties and fines
- Sensitive data resides not only on PCs, but on removable media such as USB thumb drives, CD/DVDs and SD Cards as well.
- Enterprises want one integrated server console to manage laptop encryption on all platforms including their associated policies

### Why HP Drive Encryption?



- Powered by SecureDoc from WinMagic – Industry-leading data encryption solution
- Full Volume Encryption (FVE) for complete security of data at rest
- Pre-boot authentication capability for advanced security
- Support for Self Encrypting Drives (SEDs) that are Opal compliant

### Why WinMagic?



- Recognized Industry Leader  
SC Magazine Innovator of the Year
- 15 years experience delivering data encryption solutions
- 1\* to market technologies:
  - Pre-boot Network Authentication (PBConnex)
  - OS agnostic approach with Self Encrypting Drives (SecureDoc OSA)
  - Obtained the very first NIST AES certification in the industry
- Delivering value and total cost of ownership savings
- HP Certified Drive Encryption ISV for HP notebook and desktop systems



Information you need	Where to get answers
More information about SecureDoc for HP	<a href="http://www.winmagic.com/hp">http://www.winmagic.com/hp</a>
Who should I liaise with from WinMagic to pursue a deal?	Contact <a href="mailto:hpsales@winmagic.com">hpsales@winmagic.com</a>

# Drive Encryption versions

Client version and enterprise managed version

## HP Drive Encryption

- HP Drive Encryption introduced on 2013 Commercial notebooks and desktops <sup>1</sup>
- Integrated into HP Client Security
- Easy to use
- Local control

## SecureDoc Windows Enterprise Edition<sup>2</sup>

- Enterprise class
- Manageable
- Network pre-boot authentication
- Removable media encryption

## E-delivery SKUs launched under 9F:

SecureDoc for <b>HP</b> - License	
E4S85AAE	SecureDoc WinEntr HP Lic 1-499 E-LTU
E4S86AAE	SecureDoc WinEntr HP Lic 500-999 E-LTU
E4S87AAE	SecureDoc WinEntr HP Lic 1K-4999 E-LTU
E4S88AAE	SecureDoc WinEntr HP Lic 5K+ E-LTU
SecureDoc for <b>nonHP</b> - License	
E4S89AAE	SecureDoc WinEntr noHP Lic 1-499 E-LTU
E4S90AAE	SecureDoc WinEntr noHP Lic 500-999 E-LTU
E4S91AAE	SecureDoc WinEntr noHP Lic 1K-4999 E-LTU
E4S92AAE	SecureDoc WinEntr noHP Lic 5K+ E-LTU

## HP Supported Systems

2013 CMIT NPI (Win7, Win8)

2012 CMIT (Win7)

2011 CMIT (Win7)

RPOS NPI 2013

Workstations NPI 2013 (planned)

No ThinClients

Certifications: FIPS 140-2, Common Criteria EAL4, BITS, AES validation



# HP LANDesk





# An Elite Partnership



- New Agreement offering unique capabilities to customers
  - Reseller agreement allows customers to purchase award-winning LANDesk Management Solutions from HP
  - Co-Development agreement integrates advanced HP hardware management capabilities into LANDesk Management Suite



# 3 LANDesk Pillars



## Systems Management

*Enable an organization's IT staff to remotely discover, control, administer, and manage computing hardware and software*



## Endpoint Protection

*Help organizations prevent data loss and malicious attacks... "Layered" security solutions such as patch management, antivirus, and device control provide multiple levels of defense*



## IT Service Management

*Position organizations to provide outstanding IT service desk/help desk to reduce IT operations management costs*

# LANDesk Management & Security Suite

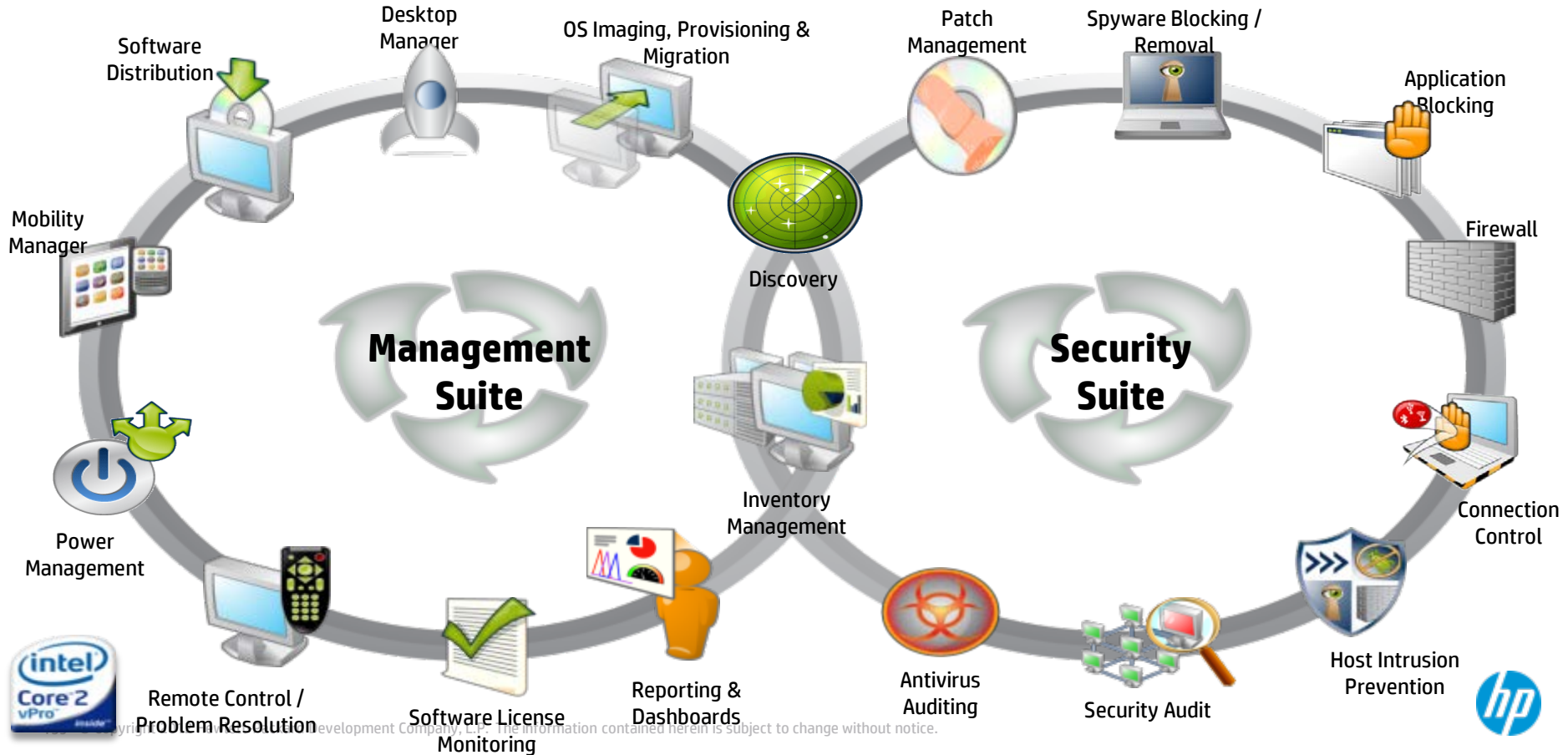

# LANDesk Product offering

E-Delivery			
PL	Part#	31 Character Part Name	Full Description
PL9F	QY369AAE	LANDesk Mgmt 1-499 E-LTU	LANDesk Management Suite License - 1-499 Nodes E-Delivery
PL9F	QY370AAE	LANDesk Mgmt 500-999 E-LTU	LANDesk Management Suite License - 500-999 Nodes E-Delivery
PL9F	QY371AAE	LANDesk Mgmt 1K-1999 E-LTU	LANDesk Management Suite License - 1000-1999 Nodes E-Delivery
PL9F	QY372AAE	LANDesk Mgmt 2K-4999 E-LTU	LANDesk Management Suite License - 2000-4999 Nodes E-Delivery
PL9F	QY373AAE	LANDesk Mgmt 5K-9999 E-LTU	LANDesk Management Suite License - 5000-9999 Nodes E-Delivery
PL9F	QY379AAE	LANDesk Security License E-LTU	LANDesk Security Suite License E-Delivery





# LANDesk 2013 Product Additions

LANDesk products are for MULTIPLE product lines: rPOS, Desktops, Notebooks, Workstations, Thin Clients

Different pricing structure implemented for multiple-devices-per-user rather than purely client-based

Microsoft SCCM plug-in, Data Analytics, Mobility and Education SKUs

Product Number	Description
E4H69AAE	HP LANDesk Asset LC MGR Console E-LTU
E4H70AAE	HP LANDesk Asset LC MGR SVR E-LTU
E4H42AAE	HP LANDesk App Virt LIC min 100 E-LTU
E4H71AAE	HP LANDesk Analytics AC LIC 1-499 E-LTU
E4H72AAE	HPLANDesk Analytics AC LIC 1K-1999 E-LTU
E4H73AAE	HPLANDesk Analytics AC LIC 2K-4999 E-LTU
E4H74AAE	HPLANDesk Analytics AC LIC 500-999 E-LTU
E4H75AAE	HPLANDesk Analytics AC LIC 5K-9999 E-LTU
E4H76AAE	HP LANDesk DA DEA BUN LIC 1-499 E-LTU
E4H77AAE	HP LANDesk DA DEA BUN LIC 500-999 E-LTU
E4H78AAE	HP LANDesk DA DEA BUN LIC 1K-1999 E-LTU
E4H79AAE	HP LANDesk DA DEA BUN LIC 2K-4999 E-LTU
E4H80AAE	HP LANDesk DA DEA BUN LIC 5K-9999 E-LTU
E4H81AAE	HP LANDesk Inventory Manager E-LTU
E4H36AAE	HP LANDesk MI SCCM LIC 1-499 E-LTU
E4H37AAE	HP LANDesk MI SCCM LIC 500-999 E-LTU
E4H38AAE	HP LANDesk MI SCCM LIC 1000-1999 E-LTU
E4H39AAE	HP LANDesk MI SCCM LIC 2000-4999 E-LTU
E4H40AAE	HP LANDesk MI SCCM LIC 5000-9999 E-LTU
E4H41AAE	HP LANDesk MI SCCM LIC 10000+ E-LTU
E4H82AAE	HP LANDesk Mobility LIC 1-499 E-LTU
E4H83AAE	HP LANDesk Mobility LIC 500-999 E-LTU
E4H84AAE	HP LANDesk Mobility LIC 1000-1999 E-LTU
E4H85AAE	HP LANDesk Mobility LIC 2000-4999 E-LTU
E4H86AAE	HP LANDesk Mobility LIC 5000-9999 E-LTU
E4H87AAE	HP LANDesk PatchMGR LIC (Stn Alone) E-LTU
E4H88AAE	HP LANDesk SecuritySteLIC(StnAlone) E-LTU
E4H43AAE	HP LANDesk SUM LIC 1-499 E-LTU
E4H44AAE	HP LANDesk SUM LIC 500-999 E-LTU
E4H45AAE	HP LANDesk SUM LIC 1000-1999 E-LTU
E4H46AAE	HP LANDesk SUM LIC 2000-4999 E-LTU
E4H47AAE	HP LANDesk SUM LIC 5000-9999 E-LTU
E4H48AAE	HP LANDesk SUM LIC 10000+ E-LTU
E4H56AAE	HP LANDesk TUM LIC 1-499 E-LTU
E4H57AAE	HP LANDesk TUM LIC 500-999 E-LTU
E4H58AAE	HP LANDesk TUM LIC 1000-1999 E-LTU
E4H59AAE	HP LANDesk TUM LIC 2000-4999 E-LTU
E4H60AAE	HP LANDesk TUM LIC 5000-9999 E-LTU
E4H61AAE	HP LANDesk TUM LIC 10000+ E-LTU





# **BDT Accessories EcoSystems**

April 2014



# 2014 Platforms

# HP ProDesk 400 Series EcoSystem

## Business Basic – Everyday Productivity

### SecureDoc WinEntr HP Lic

HP Drive Encryption, SecureDoc  
Windows Enterprise Edition  
E4S85AAE, E4S86AAE, E4S87AAE...  
E4S92AAE



### HP 250GB SATA 10K SFF HDD

Extend the life of your HP Business  
Desktop by providing additional storage  
C2T89AA



HP ProDesk 400 MT / SSF, 405, 490



### HP ProDisplay P221

Support your business needs at  
a competitive price with a large  
diagonal LED display  
C9E49AA



### HP Care Packs

3 Years Warranty Extension and  
Accidental Damage Protection  
U6578E, UF360E, HL491E



### HP SFF Integrated Work Center v3 (SFF)

Designed to convert the SFF into a Tower Configuration  
F2P06AA



### HP Business Security Lock Kit

Protect your HP Business PC from tampering or theft in  
public locations by locking-down peripherals  
PV606AA



### HP 2GB DDR3-1600 DIMM

Maximize your Business PC  
performance with HP Memory  
B4U35AA



### HP USB HD 720P v2 Business Webcam

The HP USB HD 720p Business v2  
Webcam delivers professional  
video/audio in a compact design  
D8Z08AA



### HP USB Business Speakers

Quickly and easily add stereo  
sound to your workspace with  
USB-powered speakers  
D9J19AA



### HP USB Keyboard

Features impressively durable  
design built for ease of use and  
everyday business computing  
QY776AA



### HP USB Mouse

Utilize the latest optical sensing  
technology, recording precise motion over  
a variety of surfaces without a mouse pad  
QY777AA

# HP 600 Series EcoSystem

## Business rugged features for manageability and security



### HP Care Packs

3 Years Warranty Extension and  
Accidental Damage Protection  
U7897E, UE333E, HZ560E, HL495E

### SecureDoc WinEntr HP Lic

HP Drive Encryption, SecureDoc Windows  
Enterprise Edition

E4S85AAE, E4S86AAE, E4S87AAE... E4S92AAE



### HP 500GB SATA 10K SFF HDD

Extend the life of your HP Business Desktop by providing  
additional storage  
C2T90AA



### HP 8GB DDR3-1600

Maximize your Business PC performance with HP  
Memory  
B4U40AA



### HP ProDisplay P221

Support your business needs at  
a competitive price with a large  
diagonal LED display  
C9E49AA



HP ProDesk 600, 600 G1 Tower / SSF / AIO



### HP USB Business Speakers

Quickly and easily add stereo sound to your  
workspace with USB-powered speakers  
D9J19AA



### HP USB Keyboard

Features impressively durable  
design built for ease of use and  
everyday business computing  
QY776AA



### HP Business Security Lock Kit

Protect your HP Business PC from tampering or theft in  
public locations by locking-down peripherals  
PV606AA



### HP Business Headset

the HP Business Headset provides a  
headset that is perfect for call centers,  
telephone-intensive jobs  
KQ550AA



# HP 700 Series EcoSystem

## Business Basic – Everyday Productivity

### HP Care Packs

3 Years Warranty Extension and  
Accidental Damage Protection  
U7897E, UE333E, HZ560E, HL495E



### SecureDoc WinEntr HP Lic

HP Drive Encryption, SecureDoc Windows  
Enterprise Edition

E4S85AAE, E4S86AAE, E4S87AAE... E4S92AAE



### HP 1TB SATA 10K SFF HDD

Extend the life of your HP Business Desktop by providing  
additional storage  
C2T91AA



### HP 8GB DDR3-1600

Maximize your Business PC performance with HP  
Memory  
B4U40AA

### HP EliteDisplay E241i

An extra-large screen, customizable  
comfort, and wide-angle IPS come  
together in a business display for  
every day.  
F0W81AA

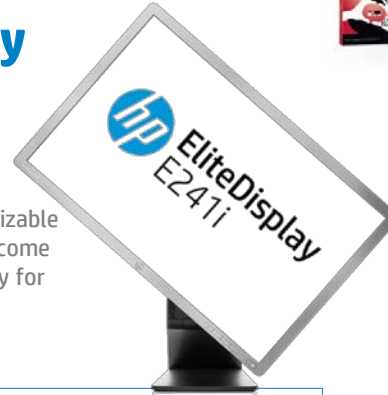

HP EliteDesk 705, 805 MT / SSF



### HP USB HD 720P v2 Business Webcam

The HP USB HD 720p Business v2  
Webcam delivers professional  
video/audio in a compact design  
D8Z08AA



### HP USB Business Speakers

Quickly and easily add stereo sound to your  
workspace with USB-powered speakers  
D9J19AA



### HP Business Security Lock Kit

Protect your HP Business PC from tampering or theft in  
public locations by locking-down peripherals  
PV606AA



### HP Wireless Keyboard & Mouse

Add an extra layer of security at the  
point of data entry with the HP USB  
SmartCard CCID Keyboard  
QY449AA



# HP 800 Series EcoSystem

## Business Basic – Everyday Productivity



### HP Care Packs

3 Years Warranty Extension and  
Accidental Damage Protection  
U7897E, UE333E, HZ560E, HL495E

### SecureDoc WinEntr HP Lic

HP Drive Encryption, SecureDoc Windows  
Enterprise Edition

E4S85AAE, E4S86AAE, E4S87AAE... E4S92AAE



### HP Intel Pro 1500 180GB SATA SED Opal1 Solid State Drive

Boost the performance and robustness of your HP Business  
Desktop PC with an HP Solid State Drive  
G4M04AA



### HP 8GB DDR3-1600

Maximize your Business PC performance with HP  
Memory  
B4U40AA

### HP EliteDisplay E241i

An extra-large screen, customizable  
comfort, and wide-angle IPS come  
together in a business display for  
every day.  
F0W81AA



HP EliteDesk 800, 800 TWR / SSF / USDT, EliteOne 800



### HP USB HD 720P v2 Business Webcam

The HP USB HD 720p Business v2  
Webcam delivers professional  
video/audio in a compact design  
D8Z08AA



### HP USB Business Speakers

Quickly and easily add stereo sound to your  
workspace with USB-powered speakers  
D9J19AA



### HP Business Security Lock Kit

Protect your HP Business PC from tampering or theft in  
public locations by locking-down peripherals  
PV606AA



### HP Wireless Keyboard & Mouse

Add an extra layer of security at the  
point of data entry with the HP USB  
SmartCard CCID Keyboard  
QY449AA



# HP EliteDesk 800 / 600 G1 DM (Mini)

## Business Basic – Everyday Productivity



### HP Care Packs

3 Years Warranty Extension and  
Accidental Damage Protection  
U7897E, UE333E, HZ560E, HL495E



### HP Tower and Stand

Designed to convert the SFF into a Tower Configuration  
G1K23AA, G1V61AA



### HP Wireless Keyboard & Mouse

Add an extra layer of security at the point of data entry with the HP USB SmartCard CCID Keyboard  
QY449AA



### HP USB 1000dpi Laser Mouse

Utilize the latest optical sensing technology, recording precise motion over a variety of surfaces without a mouse pad



QY778AA

Note – Partial list of compatible accessories

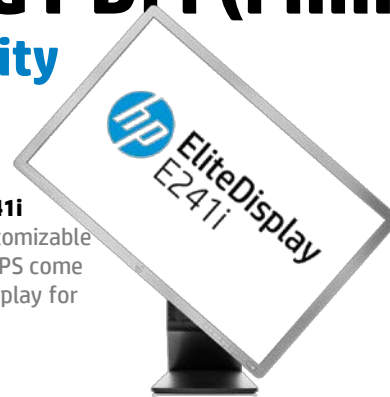

### HP EliteDisplay E241i

An extra-large screen, customizable comfort, and wide-angle IPS come together in a business display for every day.  
F0W81AA

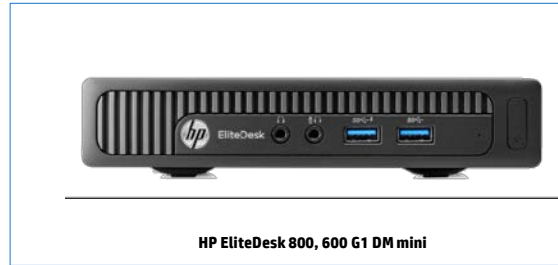

HP EliteDesk 800, 600 G1 DM mini



### HP USB HD 720P v2 Business Webcam

The HP USB HD 720p Business v2 Webcam delivers professional video/audio in a compact design  
D8Z08AA



### HP USB Business Speakers

Quickly and easily add stereo sound to your workspace with USB-powered speakers

D9J19AA

### SecureDoc WinEntr HP Lic

HP Drive Encryption, SecureDoc Windows Enterprise Edition

E4S85AAE, E4S86AAE, E4S87AAE... E4S92AAE



### HP 128Gb SED Opal 2 SSD

Boost the performance and robustness of your HP Business Desktop PC with an HP Solid State Drive  
QV063AA



### HP 2GB / 4GB / 8GB DDR3-1600

Maximize your Business PC performance with HP Memory

B4U38AA, B4U39AA, B4U40AA



# HP ProOne 400 AIO Series EcoSystem

## Business Basic – Everyday Productivity

### SecureDoc WinEntr HP Lic

HP Drive Encryption, SecureDoc  
Windows Enterprise Edition  
E4S85AAE, E4S86AAE, E4S87AAE...  
E4S92AAE



### HP 1TB SATA 6.0Gb/s Hard Drive

Serial ATA provides faster data transfer speeds, better system cooling airflow, more bandwidth, more headroom for speed increases  
QK555AA



### HP 2GB DDR3-1600 SODIMM

Maximize your Business PC performance with HP Memory  
B4U38AA



HP ProOne 400 NT



### HP USB Keyboard

Features impressively durable design built for ease of use and everyday business computing  
QY776AA



### HP Dual Output USB Graphics Adapter

C5U89AA



### HP Care Packs

3 Years Warranty Extension and  
Accidental Damage Protection  
U6578E, UF360E, HL491E



### HP Slim 8X SATA SuperMulti Drive BLK

Now store up to 8.5 GB of your data or record up to 4 hours of DVD-quality video  
QS209AA



### HP UltraSlim Cable Lock Kit

Protect your HP Business PC from tampering or theft in public locations by locking-down peripherals

H4D73AA



### HP USB Mouse

Utilize the latest optical sensing technology, recording precise motion on a variety of surfaces without a mouse pad

QY777AA



# HP ProOne 600 AIO Series EcoSystem

## Business Basic – Everyday Productivity

### SecureDoc WinEntr HP Lic

HP Drive Encryption, SecureDoc  
Windows Enterprise Edition  
E4S85AAE, E4S86AAE, E4S87AAE...  
E4S92AAE



### HP 500GB SATA 6.0Gb/s Hard Drive

Serial ATA provides faster data transfer speeds, better system cooling airflow, more bandwidth, more headroom for speed increases  
QK554AA



### HP 4GB DDR3-1600 SODIMM

Maximize your Business PC performance with HP Memory  
B4U39AA



HP ProOne 600



### HP Slim BDXL Blu-Ray Writer Drive

Quickly and easily back up your data and create and edit professional-quality HD video content  
E0X94AA



### HP USB Keyboard

Features impressively durable design built for ease of use and everyday business computing  
QY776AA

### HP Care Packs

3 Years Warranty Extension and Accidental Damage Protection  
U6578E, UF360E, HL491E



### HP Height Adjustable and Reclining Stand

Gives you the freedom to create a unique space that works for you  
C1N43AA



### HP UltraSlim Cable Lock Kit

Protect your HP Business PC from tampering or theft in public locations by locking-down peripherals  
H4D73AA



### HP USB Mouse

Utilize the latest optical sensing technology, recording precise motion over a variety of surfaces without a mouse pad  
QY777AA

# HP EliteOne 700 AIO Series EcoSystem

## Business Basic – Everyday Productivity



**HP Care Packs**  
3 Years Warranty Extension and  
Accidental Damage Protection  
U6578E, UF360E, HL491E



**HP Height Adjustable and Reclining Stand**  
Gives you the freedom to create a unique space that works for  
you C1N43AA



**HP UltraSlim Cable Lock Kit**  
Protect your HP Business PC from tampering or theft in  
public locations by locking-down peripherals  
H4D73AA



**HP USB Mouse**  
Utilize the latest optical sensing technology,  
recording precise motion over a variety of  
surfaces without a mouse mat  
QY777AA

Note – Partial list of compatible accessories



### SecureDoc WinEntr HP Lic

HP Drive Encryption, SecureDoc  
Windows Enterprise Edition  
E4S85AAE, E4S86AAE, E4S87AAE...  
E4S92AAE



### HP 128GB SATA Solid State Drive Desktop

Boost the performance and robustness  
of your HP Business Desktop PC with an  
HP Solid State Drive  
E1C6AA



### HP 8GB DDR3-1600 SODIMM

Maximize your Business PC  
performance with HP Memory  
B4U40AA



### HP Slim BDXL Blu-Ray Writer Drive

Quickly and easily back up your  
data and create and edit  
professional-quality HD video

E0X94AA



### HP USB Keyboard

Features impressively durable  
design built for ease of use and  
everyday business computing

QY776AA

# HP EliteOne 800 AIO Series EcoSystem

## Business Basic – Everyday Productivity



### HP Care Packs

3 Years Warranty Extension and  
Accidental Damage Protection

U6578E, UF360E, HL491E



### HP Height Adjustable and Reclining Stand

Gives you the freedom to create a unique space that works for you C1N43AA



### HP UltraSlim Cable Lock Kit

Protect your HP Business PC from tampering or theft in public locations by locking-down peripherals

H4D73AA



### HP USB 1000dpi Laser Mouse

Utilize the latest optical sensing technology, recording precise motion over a variety of surfaces without a mouse pad

QY778AA

Note – Partial list of compatible accessories



HP EliteOne 800 NT

### SecureDoc WinEntr HP Lic

HP Drive Encryption, SecureDoc  
Windows Enterprise Edition

E4S85AAE, E4S86AAE, E4S87AAE...  
E4S92AAE



### HP 500GB SATA 6G 2.5 (8GB Cache) SSHD Drive

Boost the performance and robustness of your HP Business Desktop PC with an HP Solid State Drive

E1C62AA



### HP 8GB DDR3-1600 SODIMM

Maximize your Business PC performance with HP Memory

B4U40AA



### HP Slim BDXL Blu-Ray Writer Drive

Quickly and easily back up your data and create and edit

professional-quality HD video content

E0X94AA



### HP USB Keyboard

Features impressively durable design built for ease of use and everyday business computing

QY776AA

# Thank You !

